

GREENDOM



M





✦ ✨ 📺 | SMART LED SYSTEMS





LED OUTDOOR WALL LIGHTS





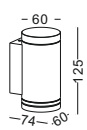





code **GD-LWA215**
 casing aluminum / black painting
 lamping COB 6W / Ra>90 / 430LM
 Beam 15/24/38/60 degree
 2700K/3000K/4000K/6000K
 installation     IP65

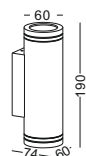

surface customizable
 white paint similar to RAL9003
 concrete grey paint similar to RAL7037

code **GD-LWA216**
 casing aluminum / black painting
 lamping COB 2x6W / Ra>90 / 860LM
 Beam 15/24/38/60 degree
 2700K/3000K/4000K/6000K
 installation     IP65







surface customizable
 white paint similar to RAL9003
 concrete grey paint similar to RAL7037

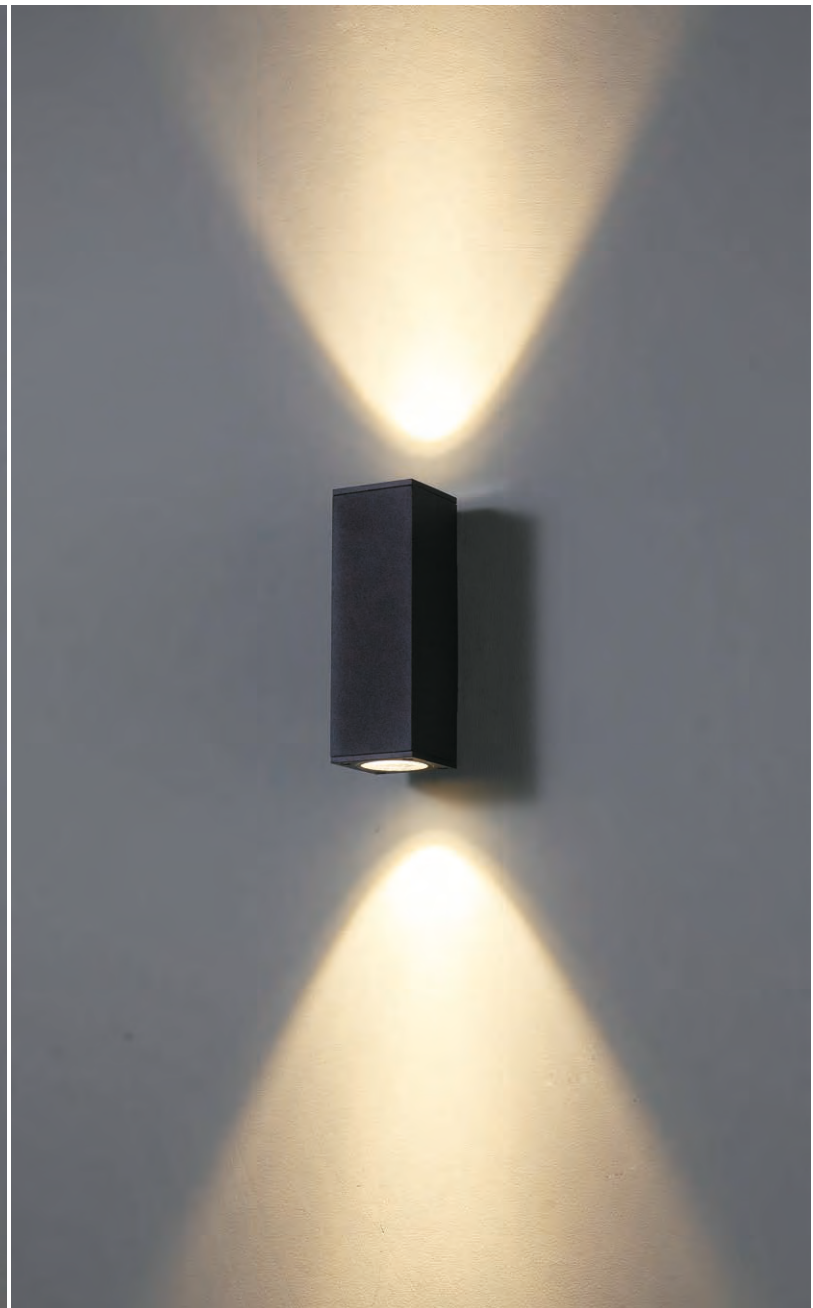
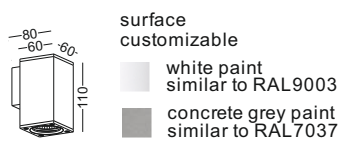

code **GD-LWA253**
 casing aluminum / black painting
 lamping COB 6W / Ra>90 /430LM
 Beam 15/24/38/60 degree
 2700K/3000K/4000K/6000K
 installation     IP65



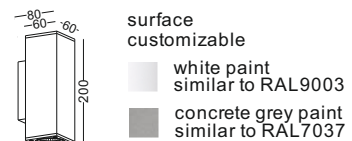

code **GD-LWA254**
 casing aluminum / black painting
 lamping COB 2x6W / Ra>90 /860LM
 Beam 15/24/38/60 degree
 2700K/3000K/4000K/6000K
 installation     IP65











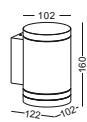

code **GD-LWA217**
 casing aluminum / black painting
 lamping COB 12W / Ra>90 / 900LM
 Beam 15/24/38/60 degree
 2700K/3000K/4000K/6000K
 installation     IP65



surface customizable
 white paint similar to RAL9003
 concrete grey paint similar to RAL7037

code **GD-LWA218**
 casing aluminum / black painting
 lamping COB 2x12W / Ra>90 / 1800LM
 Beam 15/24/38/60 degree
 2700K/3000K/4000K/6000K
 installation     IP65

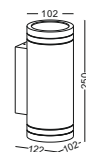





surface customizable
 white paint similar to RAL9003
 concrete grey paint similar to RAL7037

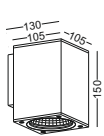

code **GD-LWA255**
 casing aluminum / black painting
 lamping COB 12W / Ra>90 /900LM
 Beam 15/24/38/60 degree
 2700K/3000K/4000K/6000K
 installation     IP65



surface customizable
 white paint similar to RAL9003
 concrete grey paint similar to RAL7037

code **GD-LWA256**
 casing aluminum / black painting
 lamping COB 2x12W / Ra>90 /1800LM
 Beam 15/24/38/60 degree
 2700K/3000K/4000K/6000K
 installation     IP65

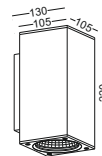





surface customizable
 white paint similar to RAL9003
 concrete grey paint similar to RAL7037

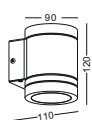

code **GD-LWA173A**
 casing aluminum / black painting
 lamping COB 5W / Ra>90 / 430LM
 Beam 15/24/38/60 degree
 2700K/3000K/4000K/6000K
 installation     IP65



surface customizable
 white paint similar to RAL9003
 concrete grey paint similar to RAL7037

code **GD-LWA174A**
 casing aluminum / black painting
 lamping COB 2x5W / Ra>90 / 860LM
 Beam 15/24/38/60 degree
 2700K/3000K/4000K/6000K
 installation     IP65





surface customizable
 white paint similar to RAL9003
 concrete grey paint similar to RAL7037





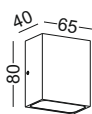

code **GD-LWA250**
 casing aluminum / black painting
 lamping LED 1W / Ra>80 /70LM
 Beam NO LENSE
 2700K/3000K/4000K/6000K
 installation     IP65

surface customizable
 white paint similar to RAL9003
 concrete grey paint similar to RAL7037



code **GD-LWA251**
 casing aluminum / black painting
 lamping LED 2X1W / Ra>80 /140LM
 Beam NO LENSE
 2700K/3000K/4000K/6000K
 installation     IP65



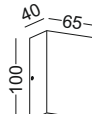

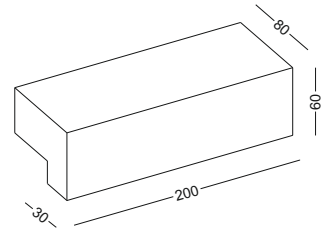
surface customizable
 white paint similar to RAL9003
 concrete grey paint similar to RAL7037



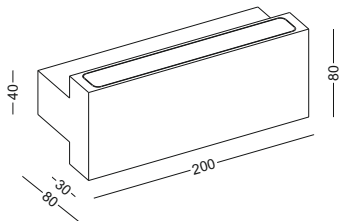

code **GD-LWA414**
 casing aluminum / black painting
 lamping LED 9W / Ra>80 / 900LM
 Beam wide flood
 2700K/3000K/4000K/6000K
 installation     IP65



code **GD-LWA415**
 casing aluminum / black painting
 lamping LED 2x9W / Ra>80 / 1800LM
 Beam wide flood
 2700K/3000K/4000K/6000K
 installation     IP65

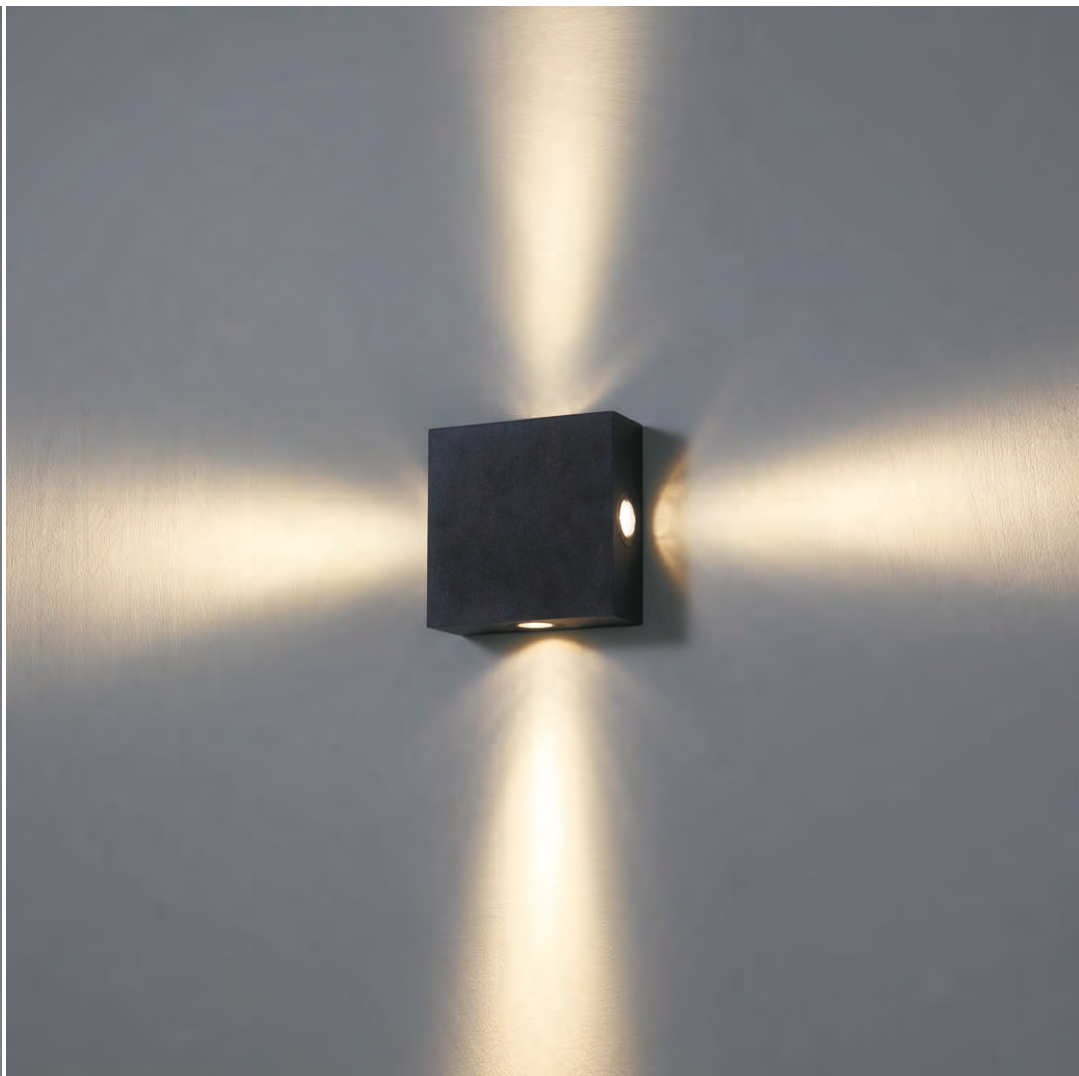

code **GD-LWA248**
 casing aluminum / black painting
 lamping LED 2x3W / Ra>80 /240LM
 Beam 10/20/30 degree
 2700K/3000K/4000K/6000K
 installation     IP65

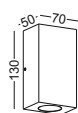

surface customizable
 white paint similar to RAL9003
 concrete grey paint similar to RAL7037

code **GD-LWA249**
 casing aluminum / black painting
 lamping LED 4x3W / Ra>80 /480LM
 Beam 10/20/30 degree
 2700K/3000K/4000K/6000K
 installation     IP65

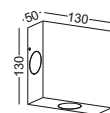

surface customizable
 white paint similar to RAL9003
 concrete grey paint similar to RAL7037



2021
NEW
OUTDOOR
WALL
LIGHTS

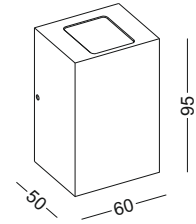

code **GD-LWA412**
casing aluminum / black painting
lamping LED 3W / Ra>80 / 120LM
Beam 8 degree
2700K/3000K/4000K/6000K
installation     IP65

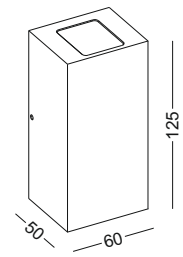

code **GD-LWA413**
casing aluminum / black painting
lamping LED 2x3W / Ra>80 / 240LM
Beam 8 degree
2700K/3000K/4000K/6000K
installation     IP65





code **GD-LWA213**
 casing aluminum / black painting
 lamping COB 9W / Ra>90 /800LM
 Beam acrylic diffuser
 2700K/3000K/4000K/6000K
 installation IP65

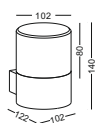

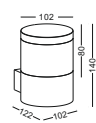

surface customizable
 white paint similar to RAL9003
 concrete grey paint similar to RAL7037

code **GD-LWA214**
 casing aluminum / black painting
 lamping COB 9W / Ra>90 /800LM
 Beam acrylic diffuser
 2700K/3000K/4000K/6000K
 installation IP65







surface customizable
 white paint similar to RAL9003
 concrete grey paint similar to RAL7037

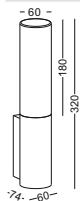



code **GD-LWA210**
 casing aluminum / black painting
 lamping COB 6W / Ra>90 /430LM
 Beam acrylic diffuser
 2700K/3000K/4000K/6000K
 installation     IP65

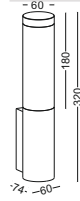

surface customizable
 white paint similar to RAL9003
 concrete grey paint similar to RAL7037

code **GD-LWA211**
 casing aluminum / black painting
 lamping COB 6W / Ra>90 /430LM
 Beam acrylic diffuser
 2700K/3000K/4000K/6000K
 installation     IP65



surface customizable
 white paint similar to RAL9003
 concrete grey paint similar to RAL7037



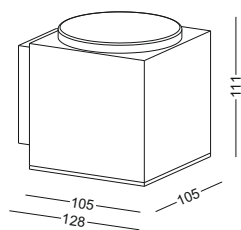

code **GD-LWA396**
casing aluminum / black painting
lamping LED 10W / Ra>80 /1000LM
Beam acrylic diffuser
2700K/3000K/4000K/6000K
installation     IP65

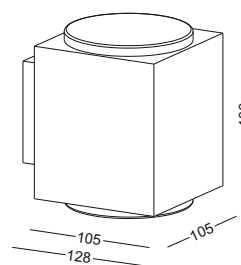

code **GD-LWA397**
casing aluminum / black painting
lamping LED 2x10W / Ra>80 /2000LM
Beam acrylic diffuser
2700K/3000K/4000K/6000K
installation     IP65

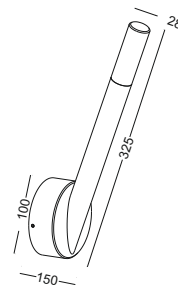

code **GD-LWA135**

casing aluminum / black painting

lamping LED 3W / Ra>80 /120LM

Beam acrylic diffuser

2700K/3000K/4000K/6000K

installation     IP65

surface

customizable

 white paint
similar to RAL9003

 concrete grey paint
similar to RAL7037

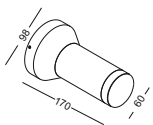

code **GD-LWA139**

casing aluminum / black painting

lamping LED 4W / Ra>80 / 400LM

Beam acrylic diffuser
2700K/3000K/4000K/6000K

installation     IP65

surface
customizable

 white paint
similar to RAL9003

 concrete grey paint
similar to RAL7037



code **GD-LWA310**

casing aluminum / black painting

lamping COB 5W / Ra>90 /430LM

Beam acrylic diffuser

2700K/3000K/4000K/6000K

installation     IP65

surface customizable  white paint similar to RAL9003

 concrete grey paint similar to RAL7037

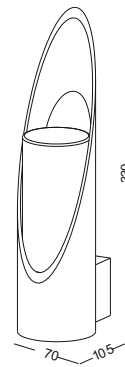

code **GD-LWA311**
 casing aluminum / black painting
 lamping COB 5W / Ra>90 / 430LM
 Beam acrylic diffuser
 2700K/3000K/4000K/6000K
 installation IP65

surface customizable
 white paint similar to RAL9003
 concrete grey paint similar to RAL7037

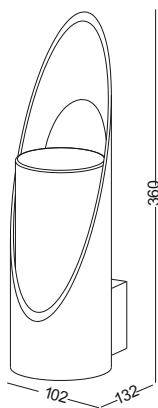

code **GD-LWA312**
 casing aluminum / black painting
 lamping COB 5W / Ra>90 / 430LM
 Beam acrylic diffuser
 2700K/3000K/4000K/6000K
 installation IP65

surface customizable
 white paint similar to RAL9003
 concrete grey paint similar to RAL7037





code **GD-LWA291A**



casing aluminum / black painting

lamping COB 2x6W / Ra>90 / 860LM

Beam acrylic diffuser

2700K/3000K/4000K/6000K

installation     IP65

surface customizable  white paint similar to RAL9003
 concrete grey paint similar to RAL7037

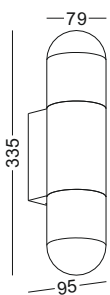

code **GD-LWA292A**
 casing aluminum / black painting
 lamping COB 2x6W / Ra>90 / 860LM
 Beam acrylic diffuser
 2700K/3000K/4000K/6000K
 installation IP65

surface customizable white paint similar to RAL9003
 concrete grey paint similar to RAL7037

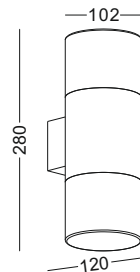

code **GD-LWA293A**
 casing aluminum / black painting
 lamping COB 2x9W / Ra>90 / 1600LM
 Beam acrylic diffuser
 2700K/3000K/4000K/6000K
 installation IP65

surface customizable white paint similar to RAL9003
 concrete grey paint similar to RAL7037



2020
SPRING
NEW
OUTDOOR
LIGHT

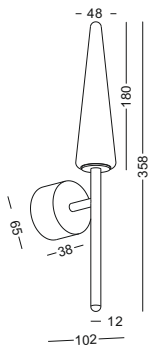

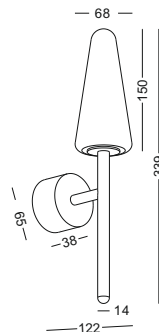

code **GD-LWA366**
 casing aluminum / black painting
 lamping LED 3W / Ra>80 /120LM
 Beam acrylic diffuser
 2700K/3000K/4000K/6000K
 installation     IP65

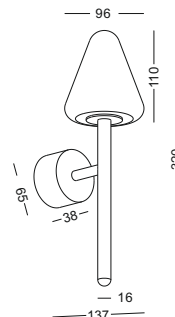

code **GD-LWA367**
 casing aluminum / black painting
 lamping LED 3W / Ra>80 /120LM
 Beam acrylic diffuser
 2700K/3000K/4000K/6000K
 installation     IP65



code **GD-LWA368**
 casing aluminum / black painting
 lamping LED 3W / Ra>80 /120LM
 Beam acrylic diffuser
 2700K/3000K/4000K/6000K
 installation     IP65





2020
SUMMER
NEW OUTDOOR
WALL/CEILING LIGHT



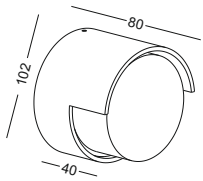



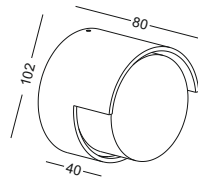

code **GD-LWA382-BK**
casing aluminum / black painting
lamping LED 4W / Ra>80 /400LM
Beam acrylic diffuser
2700K/3000K/4000K/6000K
installation     IP65

surface
customizable

 concrete grey paint
similar to RAL7037



code **GD-LWA382-WT**
casing aluminum / white painting
lamping LED 4W / Ra>80 /400LM
Beam acrylic diffuser
2700K/3000K/4000K/6000K
installation     IP65

surface
customizable

 concrete grey paint
similar to RAL7037



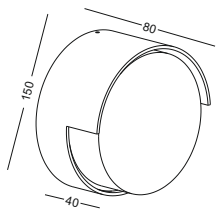



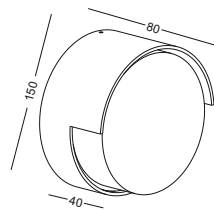

code **GD-LWA383-BK**
casing aluminum / black painting
lamping LED 6W / Ra>80 / 600LM
Beam acrylic diffuser
2700K/3000K/4000K/6000K
installation     IP65

surface
customizable

 concrete grey paint
similar to RAL7037



code **GD-LWA383-WT**
casing aluminum / white painting
lamping LED 6W / Ra>80 / 600LM
Beam acrylic diffuser
2700K/3000K/4000K/6000K
installation     IP65

surface
customizable

 concrete grey paint
similar to RAL7037



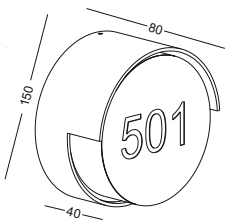





code **GD-LWA384-BK**
 casing aluminum / black painting
 lamping LED 6W / Ra>80 / 600LM
 Beam acrylic diffuser
 2700K/3000K/4000K/6000K
 installation     IP65

surface
 customizable

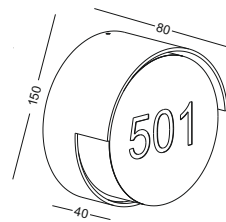
 concrete grey paint
 similar to RAL7037

characters on the cover customizable



code **GD-LWA384-WT**
 casing aluminum / white painting
 lamping LED 6W / Ra>80 / 600LM
 Beam acrylic diffuser
 2700K/3000K/4000K/6000K
 installation     IP65

surface
 customizable

 concrete grey paint
 similar to RAL7037

characters on the cover customizable



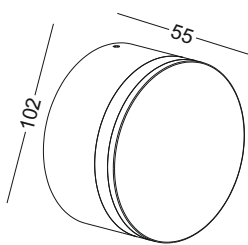

code **GD-LWA385**
 casing aluminum / black painting
 lamping LED 4W / Ra>80 / 400LM
 Beam acrylic diffuser
 2700K/3000K/4000K/6000K
 installation IP65

surface customizable
 concrete grey paint similar to RAL7037
 white paint similar to RAL9003

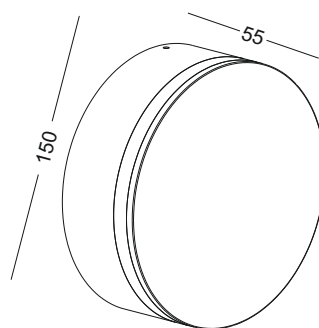

code **GD-LWA386**
 casing aluminum / black painting
 lamping LED 12W / Ra>80 / 1200LM
 Beam acrylic diffuser
 2700K/3000K/4000K/6000K
 installation IP65

surface customizable
 concrete grey paint similar to RAL7037
 white paint similar to RAL9003



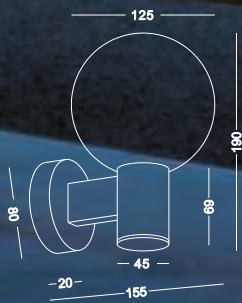

code **GD-LWA381**

casing aluminum / black painting

lamping COB 3W / Ra>80 /300LM

Beam acrylic diffuser

2700K/3000K/4000K/6000K

installation     IP65

surface customizable

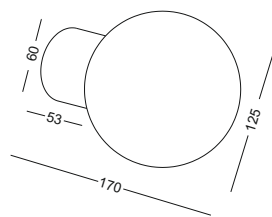

 concrete grey paint similar to RAL7037

 white paint similar to RAL9003





code **LBL272**
casing aluminum / black painting
lamping COB 5W / Ra>80 / 430LM
Beam acrylic diffuser
2700K/3000K/4000K/6000K
installation       IP65

surface
customizable

-  concrete grey paint
similar to RAL7037
-  white paint
similar to RAL9003

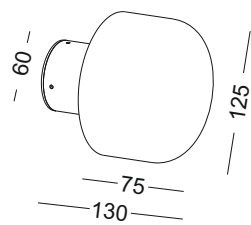



code **GD-LWA380**
casing brass shade / black painting
lamping led 6W / Ra>80 /600LM
Beam indirect light/acrylic diffuser
2700K/3000K/4000K/6000K
installation    IP65



lamp shade made by copper

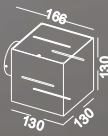

code **GD-LWA300C-BK**
casing aluminum / black painting
lamping LED 4X3W / Ra>80 / 1200LM
Beam 8 degree /
2700K/3000K/4000K/6000K
installation     IP65

surface customizable



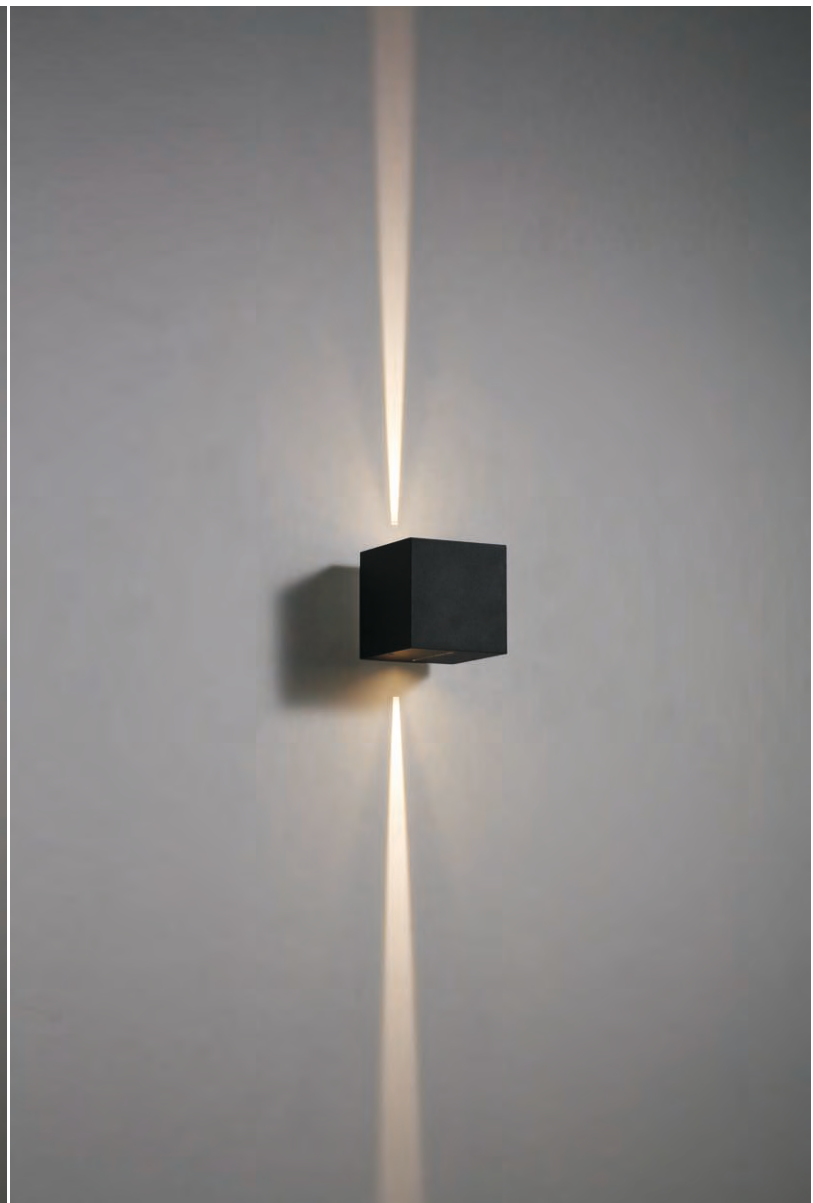
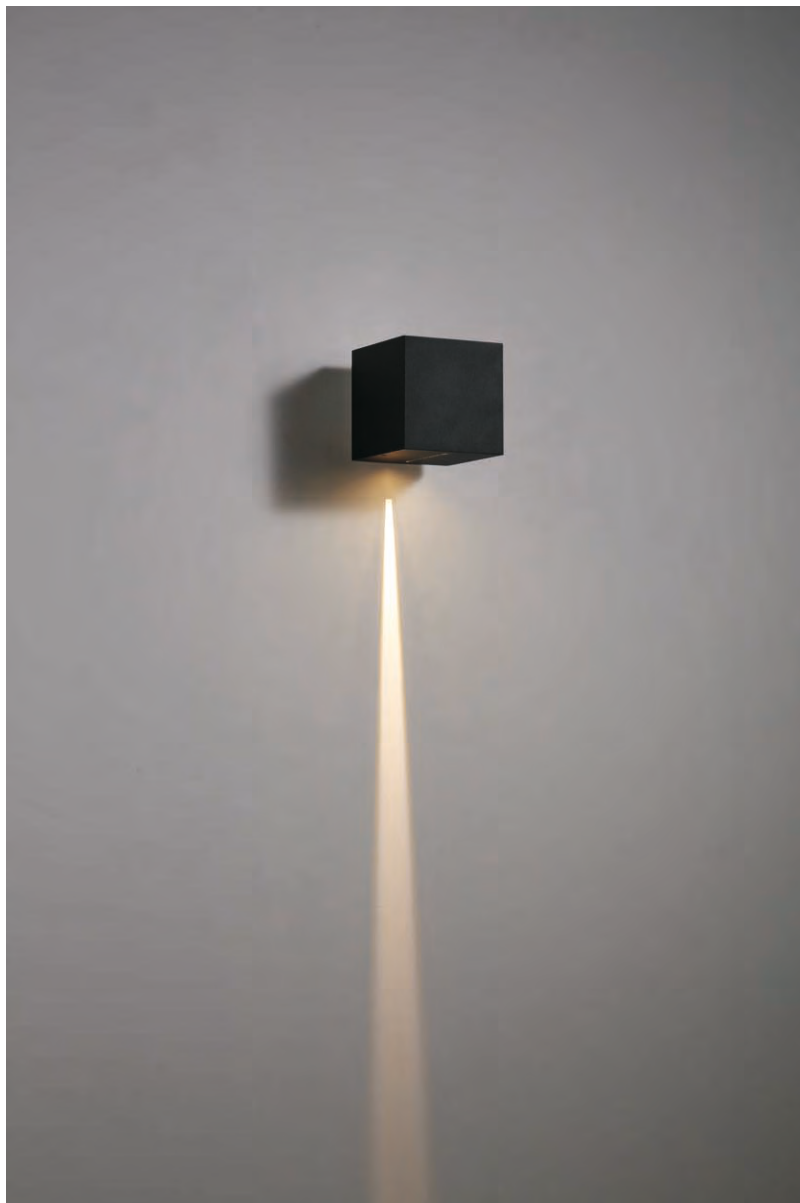

-  white paint similar to RAL9003
-  concrete grey paint similar to RAL7037

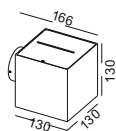

code **GD-LWA300A-BK**
 casing aluminum / black painting
 lamping LED 3W / Ra>80 /300LM
 Beam 8 degree /
 2700K/3000K/4000K/6000K
 installation     IP65





surface
 customizable

-  white paint
 similar to RAL9003
-  concrete grey paint
 similar to RAL7037

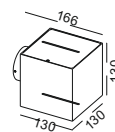
code **GD-LWA300B-BK**
 casing aluminum / black painting
 lamping LED 2X3W / Ra>80 /600LM
 Beam 8 degree /
 2700K/3000K/4000K/6000K
 installation     IP65



surface
 customizable

-  white paint
 similar to RAL9003
-  concrete grey paint
 similar to RAL7037



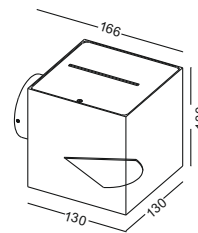
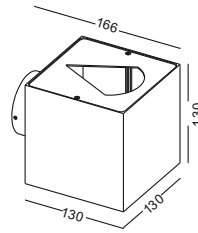
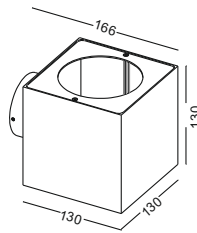
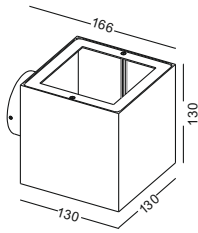

code **GD-LWA300D-BK**

surface customizable white paint similar to RAL9003 concrete grey paint similar to RAL7037

casing aluminum / black painting / lamping COB 2X3W / Ra>90 / 500LM / up 80 degree+down 80 degree / 2700K/3000K/4000K/6000K

installation IP65 up and down cover sheet can be laser cut to other drawings or shape to get different light shape

code **GD-LWA300E-BK**

surface customizable white paint similar to RAL9003 concrete grey paint similar to RAL7037

casing aluminum / black painting / lamping COB 2X3W / Ra>90 / 500LM / up 90 degree+down 90 degree / 2700K/3000K/4000K/6000K

installation IP65 up and down cover sheet can be laser cut to other drawings or shape to get different light shape

code **GD-LWA300F-BK**

surface customizable white paint similar to RAL9003 concrete grey paint similar to RAL7037

casing aluminum / black painting / lamping COB 2X3W / Ra>90 / 500LM / up 60 degree+down 60 degree / 2700K/3000K/4000K/6000K

installation IP65 up and down cover sheet can be laser cut to other drawings or shape to get different light shape





code **GD-LWA300H-BK**

surface customizable white paint similar to RAL9003 concrete grey paint similar to RAL7037

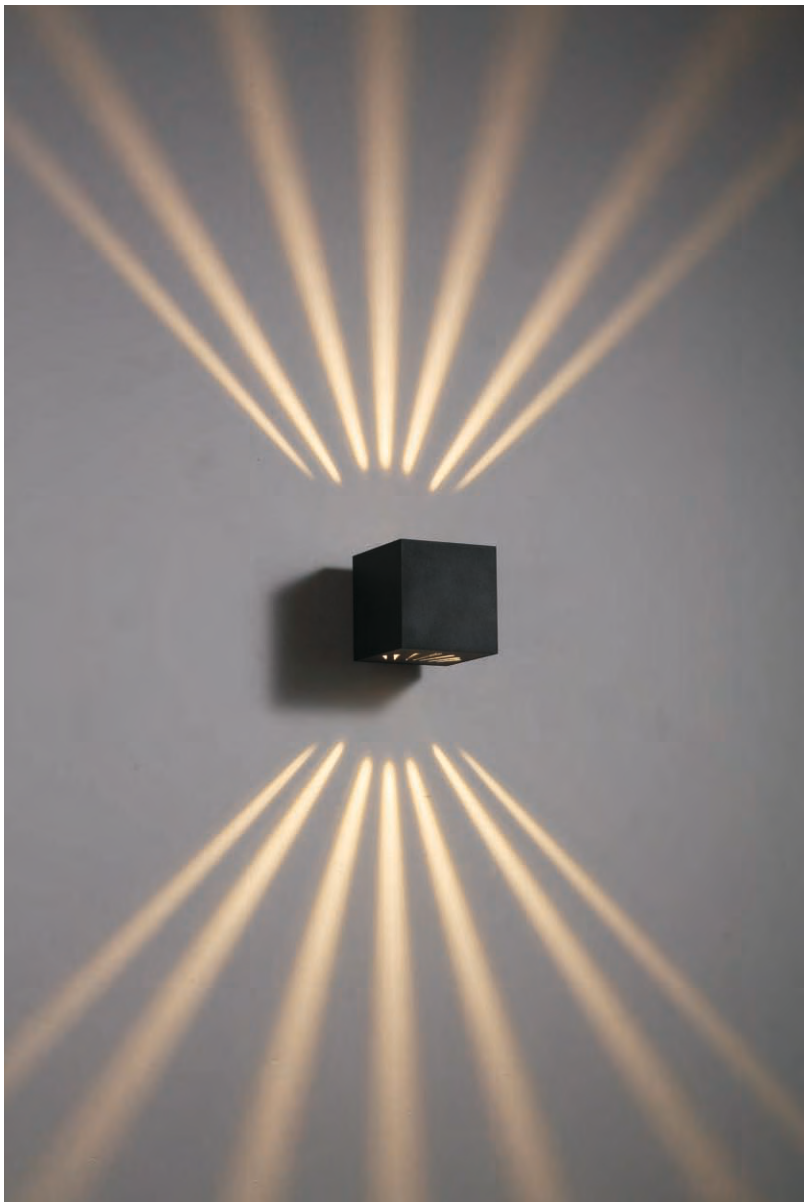
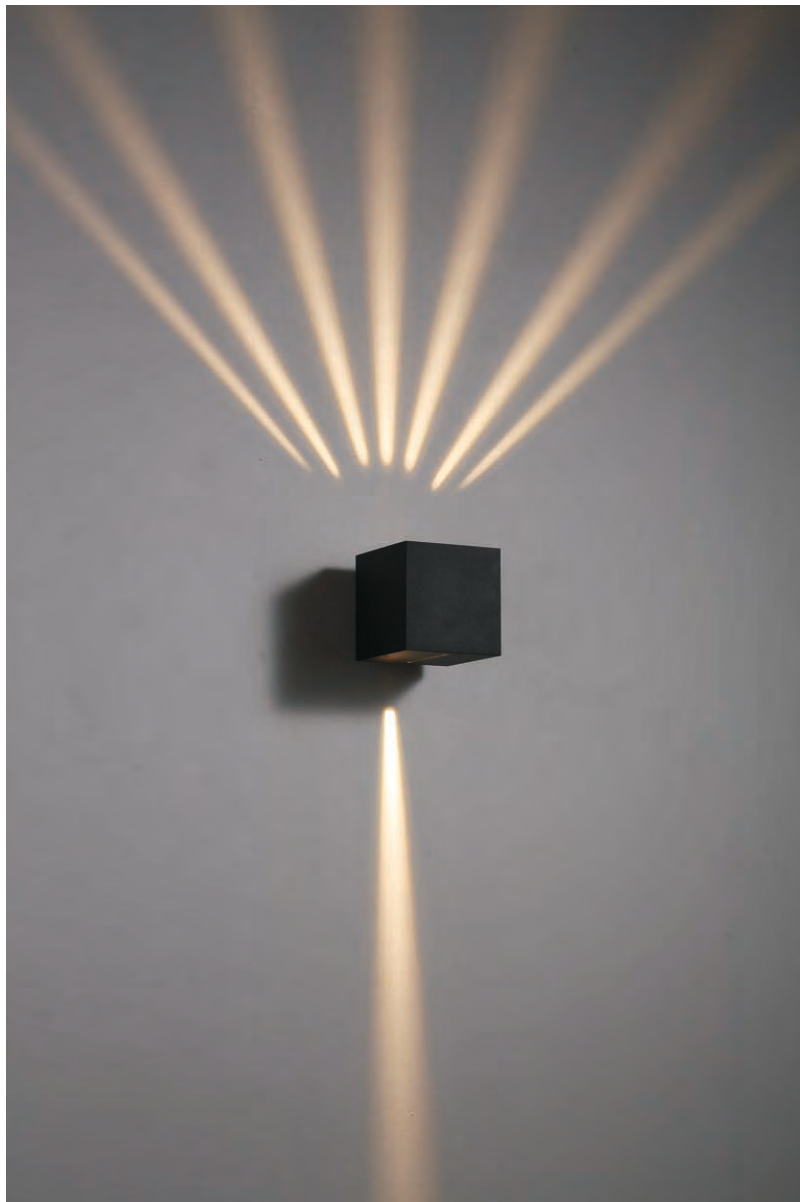

casing aluminum / black painting / lamping COB 2X3W / Ra>90 / 500LM / up 60 degree+down 8 degree / 2700K/3000K/4000K/6000K



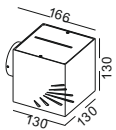

installation IP65 up and down cover sheet can be laser cut to other drawings or shape to get different light shape





code **GD-LWA300J-BK**
 casing aluminum / black painting
 lamping COB 2X3W / Ra>90 / 500LM
 Beam down 8 degree /
 2700K/3000K/4000K/6000K
 installation     IP65

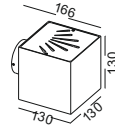

surface customizable
 white paint similar to RAL9003
 concrete grey paint similar to RAL7037

code **GD-LWA300G-BK**
 casing aluminum / black painting
 lamping COB 2X3W / Ra>90 / 500LM
 Beam dismissed light /
 2700K/3000K/4000K/6000K
 installation     IP65



surface customizable
 white paint similar to RAL9003
 concrete grey paint similar to RAL7037



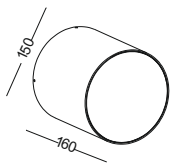
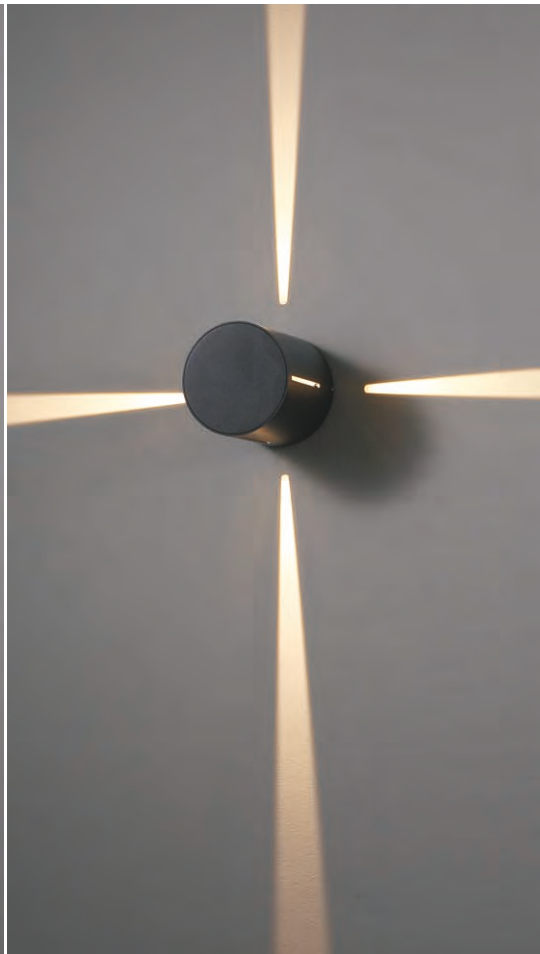
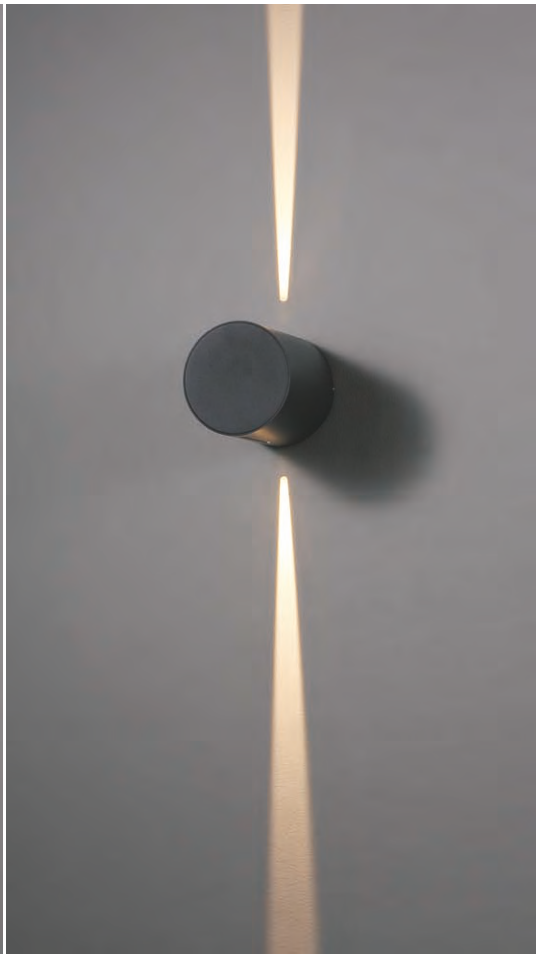



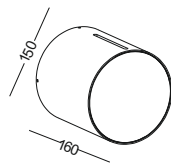

code **GD-LWA405-BK**
casing aluminum / black painting
lamping LED 3W / Ra>80 / 300LM
Beam 8 degree
2700K/3000K/4000K/6000K
installation     IP65

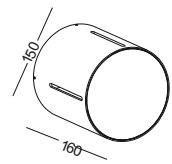

code **GD-LWA406-BK**
casing aluminum / black painting
lamping LED 2x3W / Ra>80 / 600LM
Beam 8 degree
2700K/3000K/4000K/6000K
installation     IP65



code **GD-LWA407-BK**
casing aluminum / black painting
lamping LED 4x3W / Ra>80 / 1200LM
Beam 8 degree
2700K/3000K/4000K/6000K
installation     IP65

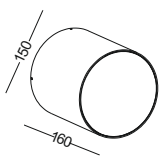

code **GD-LWA408-BK**
 casing aluminum / black painting
 lamping LED 3W / Ra>90 /300LM
 Beam 60 degree
 2700K/3000K/4000K/6000K
 installation     IP65

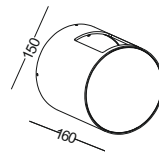

code **GD-LWA409-BK**
 casing aluminum / black painting
 lamping LED 2x3W / Ra>90 /600LM
 Beam 60 degree
 2700K/3000K/4000K/6000K
 installation     IP65



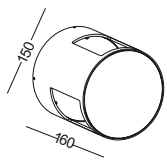

code **GD-LWA410-BK**
 casing aluminum / black painting
 lamping LED 3X3W / Ra>90 / 900LM
 Beam 60 degree
 2700K/3000K/4000K/6000K
 installation     IP65

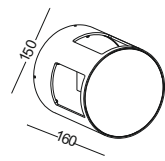

code **GD-LWA411-BK**
 casing aluminum / black painting
 lamping LED 4x3W / Ra>90 / 1200LM
 Beam 60 degree
 2700K/3000K/4000K/6000K
 installation     IP65

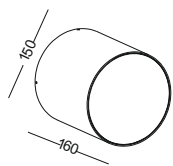
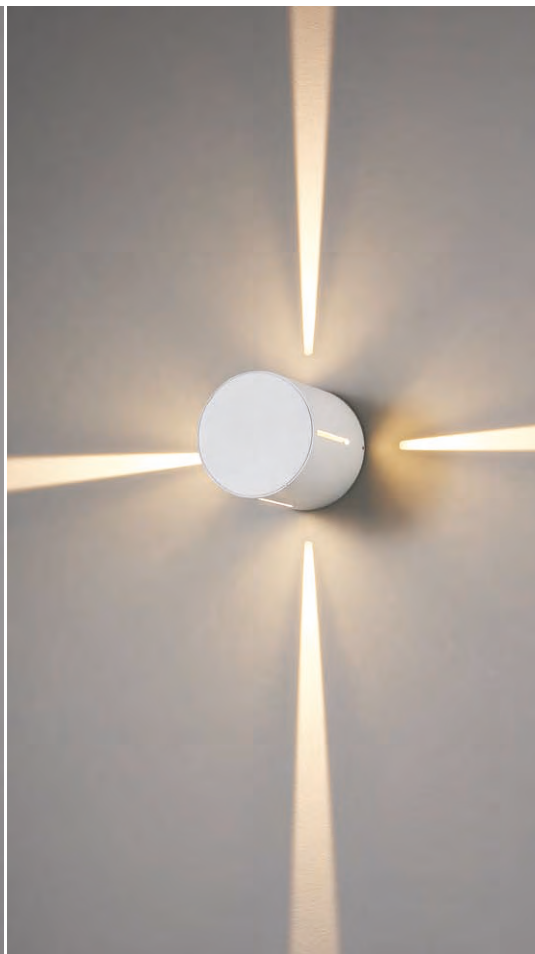

code **GD-LWA405-WT**
 casing aluminum / white painting
 lamping LED 3W / Ra>80 /300LM
 Beam 8 degree
 2700K/3000K/4000K/6000K
 installation     IP65

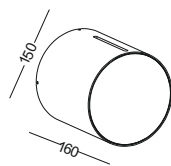

code **GD-LWA406-WT**
 casing aluminum / white painting
 lamping LED 2x3W / Ra>80 /600LM
 Beam 8 degree
 2700K/3000K/4000K/6000K
 installation     IP65

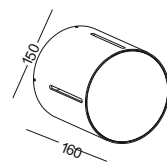

code **GD-LWA407-WT**
 casing aluminum / white painting
 lamping LED 4x3W / Ra>80 /1200LM
 Beam 8 degree
 2700K/3000K/4000K/6000K
 installation     IP65



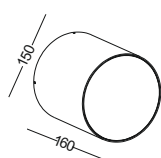



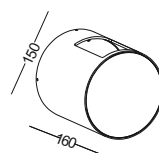

code **GD-LWA408-WT**
 casing aluminum / white painting
 lamping LED 3W / Ra>90 / 300LM
 Beam 60 degree
 2700K/3000K/4000K/6000K
 installation     IP65

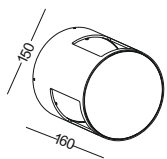
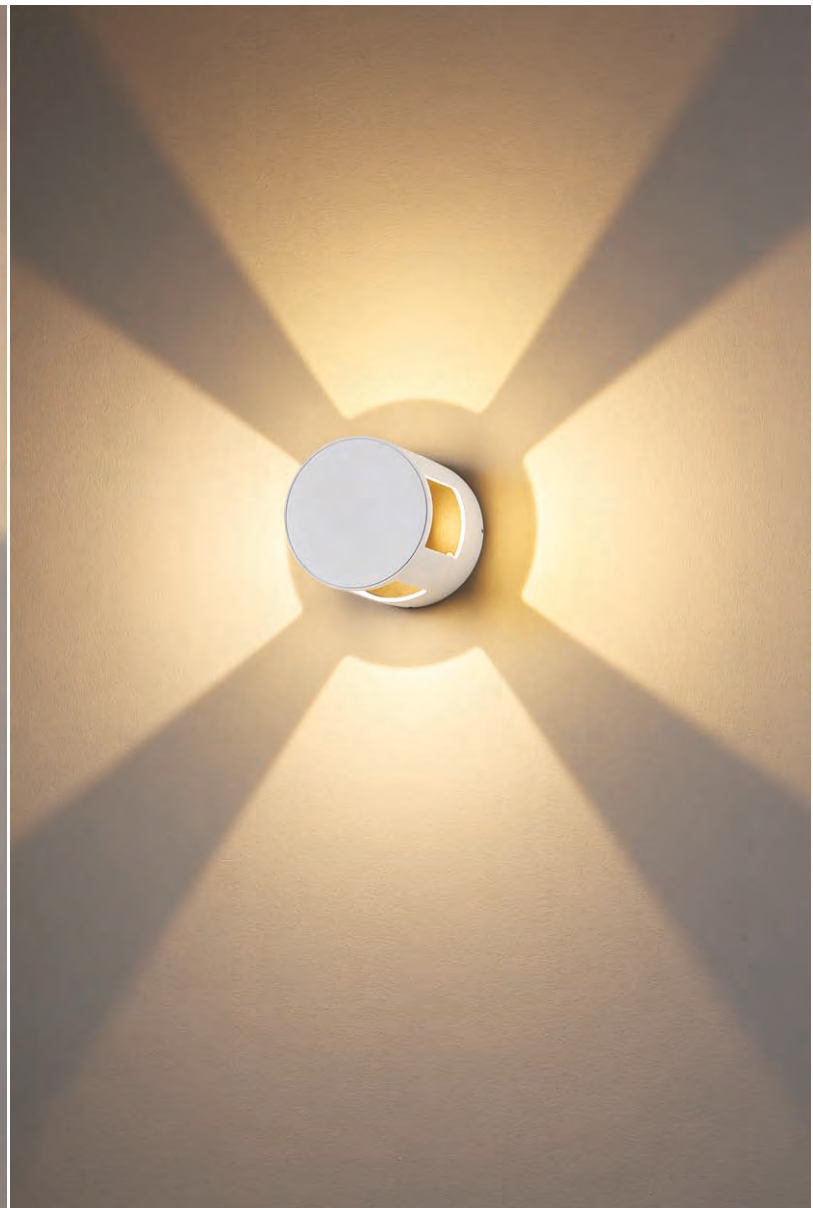





code **GD-LWA409-WT**
 casing aluminum / white painting
 lamping LED 2x3W / Ra>90 / 600LM
 Beam 60 degree
 2700K/3000K/4000K/6000K
 installation     IP65

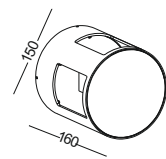

code **GD-LWA410-WT**
 casing aluminum / white painting
 lamping LED 3X3W / Ra>90 / 900LM
 Beam 60 degree
 2700K/3000K/4000K/6000K
 installation     IP65



code **GD-LWA411-WT**
 casing aluminum / white painting
 lamping LED 4x3W / Ra>90 / 1200LM
 Beam 60 degree
 2700K/3000K/4000K/6000K
 installation     IP65





code **GD-LWA288-BK**

casing aluminum / black painting

lamping LED 2X3W / Ra>80 / 600LM

Beam up and down light can be adjusted from 5 degree to 120 degree / 2700K/3000K/4000K/6000K

installation     IP65

up and down light cover sheet adjustable

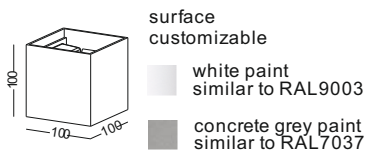

code **GD-LWA288-WT**

casing aluminum / white painting

lamping LED 2X3W / Ra>80 / 600LM



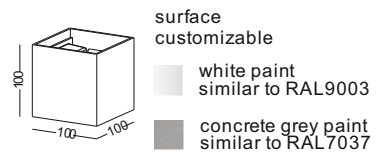

Beam up and down light can be adjusted from 5 degree to 120 degree / 2700K/3000K/4000K/6000K

installation     IP65

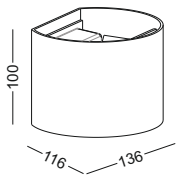



up and down light cover sheet adjustable



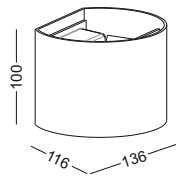

code **GD-LWA288A-BK**
 casing aluminum / black painting
 lamping LED 2X3W / Ra>80 /600LM
 Beam adjustable when moving the shield sheet inside the lamp varies from 0 to 90 degree
 2700K/3000K/4000K/6000K
 installation     IP65



code **GD-LWA288A-WT**
 casing aluminum / white painting
 lamping LED 2X3W / Ra>80 /600LM
 Beam adjustable when moving the shield sheet inside the lamp varies from 0 to 90 degree
 2700K/3000K/4000K/6000K
 installation     IP65





code **GD-LWA279**
 casing aluminum / black painting
 lamping LED 3W / Ra>80 / 120LM
 Beam down 8 degree /
 2700K/3000K/4000K/6000K
 installation IP65

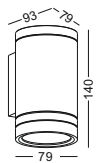

surface customizable

- white paint similar to RAL9003
- concrete grey paint similar to RAL7037

code **GD-LWA280**
 casing aluminum / black painting
 lamping LED 2X3W / Ra>80 / 240LM
 Beam up and down 8 degree /
 2700K/3000K/4000K/6000K
 installation IP65

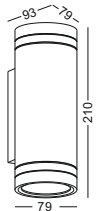

surface customizable

- white paint similar to RAL9003
- concrete grey paint similar to RAL7037

code **GD-LWA281**
 casing aluminum / black painting
 lamping up 3W/ down 6W / Ra>80 / 670LM
 Beam up 8 degree and down 38 degree
 2700K/3000K/4000K/6000K
 installation IP65

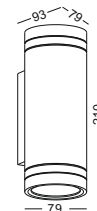

surface customizable

- white paint similar to RAL9003
- concrete grey paint similar to RAL7037





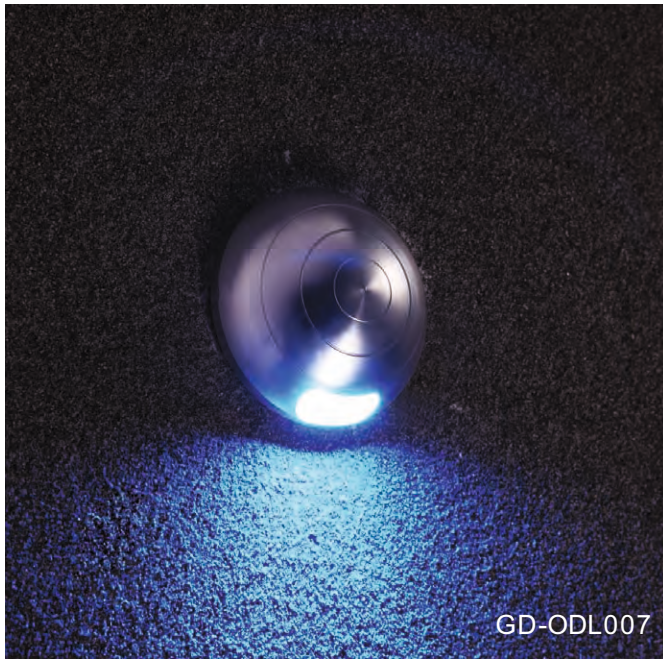

GD-ODL007



GD-ODL008

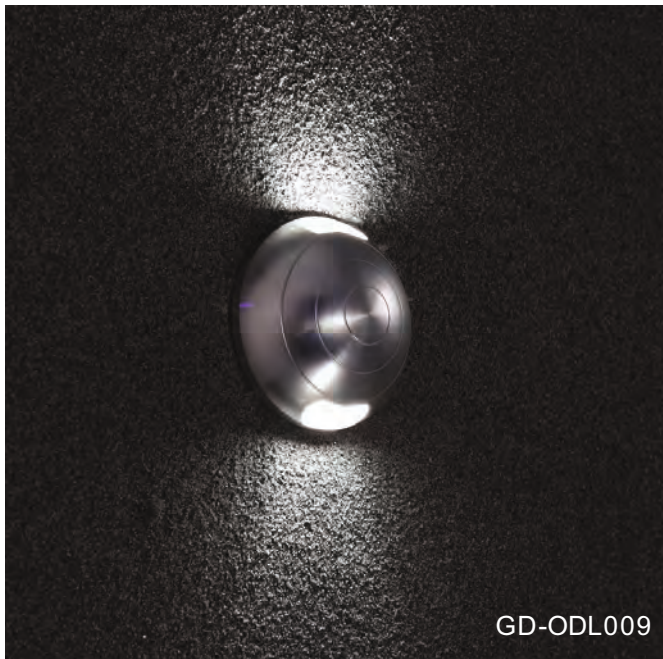

GD-ODL009

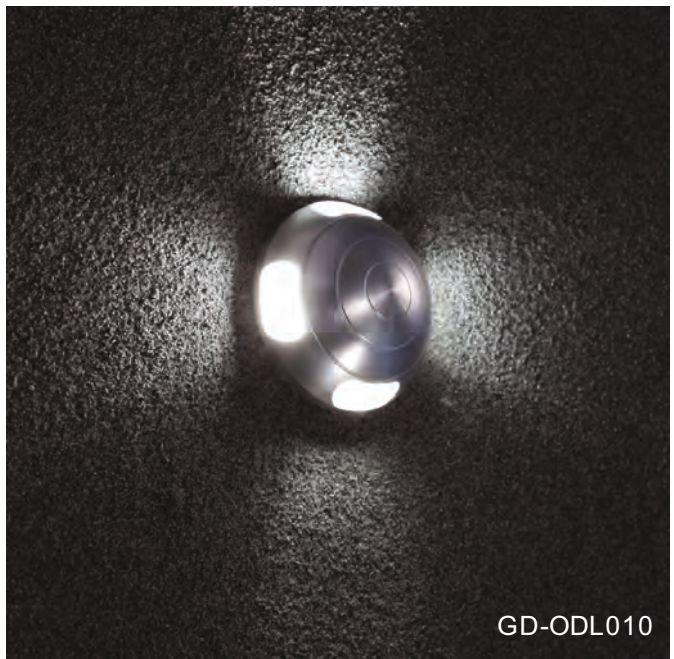

GD-ODL010

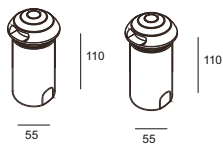

code **GD-ODL007 / GD-ODL008**

surface customizable concrete grey paint similar to RAL7037 anodized black sandblasted

casing aluminum / anodized silver / lamping LED 3W / Ra>80 / 120LM / Acrylic diffuser / 2700K/3000K/4000K/6000K red / green / blue

installation IP65 cut-off dia50x120mm for installation box

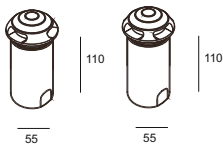

code **GD-ODL009 / GD-ODL010**

surface customizable concrete grey paint similar to RAL7037 anodized black sandblasted

casing aluminum / anodized silver / lamping LED 3W / Ra>80 / 120LM / Acrylic diffuser / 2700K/3000K/4000K/6000K red / green / blue

installation IP65 cut-off dia50x120mm for installation box

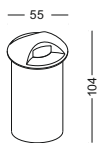

code **GD-ODL025**

surface customizable concrete grey paint similar to RAL7037 anodized black sandblasted

casing aluminum / anodized silver / lamping LED 3W / Ra>80 / 120LM / two ways light / 2700K/3000K/4000K/6000K red / green / blue

installation    **CE IP67**  cut-off dia50x100mm for installation box

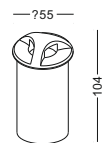

code **GD-ODL026**

surface customizable concrete grey paint similar to RAL7037 anodized black sandblasted

casing aluminum / anodized silver / lamping LED 3W / Ra>80 / 120LM / three ways light / 2700K/3000K/4000K/6000K red / green / blue

installation    **CE IP67**  cut-off dia50x100mm for installation box

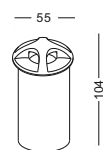

code **GD-ODL027**

surface customizable concrete grey paint similar to RAL7037 anodized black sandblasted

casing aluminum / anodized silver / lamping LED 3W / Ra>80 / 120LM / four ways light / 2700K/3000K/4000K/6000K red / green / blue



installation    **CE IP67**  cut-off dia50x100mm for installation box

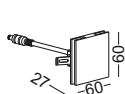

code **GD-ODL043**
 casing aluminum / anodized black
 lamping LED 1W / Ra>80 /70LM
 Beam acrylic diffuser
 2700K/3000K/4000K/6000K
 red / green / blue
 installation    IP65

 cut-off dia55x100mm
 for installation box





surface
 customizable
 white paint
 similar to RAL9003
 concrete grey paint
 similar to RAL7037

code **GD-ODL044**
 casing aluminum / anodized black
 lamping LED 1W / Ra>80 /70LM
 Beam acrylic diffuser
 2700K/3000K/4000K/6000K
 red / green / blue
 installation    IP65

 cut-off dia55x100mm
 for installation box



surface
 customizable
 white paint
 similar to RAL9003
 concrete grey paint
 similar to RAL7037



code **GD-ODL041**
 casing aluminum / anodized black
 lamping LED 1W / Ra>80 / 70LM
 Beam acrylic diffuser
 2700K/3000K/4000K/6000K
 red / green / blue
 installation    IP65

 cut-off dia55x100mm
 for installation box

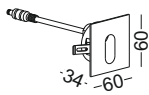

surface customizable
 white paint similar to RAL9003
 concrete grey paint similar to RAL7037

code **GD-ODL042**
 casing aluminum / anodized black
 lamping LED 1W / Ra>80 / 70LM
 Beam acrylic diffuser
 2700K/3000K/4000K/6000K
 red / green / blue
 installation    IP65

 cut-off dia55x100mm
 for installation box

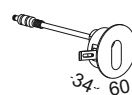

surface customizable
 white paint similar to RAL9003
 concrete grey paint similar to RAL7037



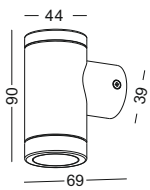

code **GD-LWA369**
 casing all in brass
 finishing polished
 lamping COB 3W / Ra>90 /300LM
 Beam 10 / 20 / 30 degree /
 2700K/3000K/4000K/6000K
 installation     IP65

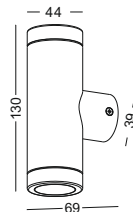

code **GD-LWA370**
 casing all in brass
 finishing polished
 lamping COB 2X3W / Ra>90 /600LM
 Beam 10 / 20 / 30 degree /
 2700K/3000K/4000K/6000K
 installation     IP65



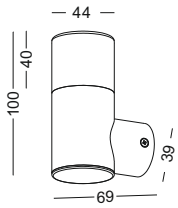

code **GD-LWA371**
casing all in brass
finishing polished
lamping COB 3W / Ra>90 /300LM
Beam acrylic diffuser
2700K/3000K/4000K/6000K
installation     IP65

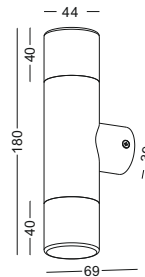

code **GD-LWA372**
casing all in brass
finishing polished
lamping COB 2X3W / Ra>90 /600LM
Beam acrylic diffuser
2700K/3000K/4000K/6000K
installation     IP65





**LED
UNDERGROUND
LIGHT**

12V / 24V / 220V INPUT UNDERGROUND SPOTLIGHT

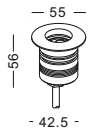

code **GD-ODL031** Stainless steel 316 cover / aluminum heat sink / aluminum installation case
 casing aluminum+stainless steel / lamping LED 3W / Ra>80 /210LM / Beam 15/30/60 degree / 2700K/3000K/4000K/6000K red / green / blue
 installation supplied with external 100-240V input Ip67 LED driver /check installation in next page



code **GD-ODL032** Stainless steel 316 cover / aluminum heat sink / aluminum installation case
 casing aluminum+stainless steel / lamping LED 6W / Ra>80 /420LM / Beam 15/30/60 degree / 2700K/3000K/4000K/6000K red / green / blue
 installation supplied with external 100-240V input Ip67 LED driver /check installation in next page

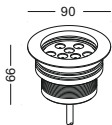

code **GD-ODL033** Stainless steel 316 cover / aluminum heat sink / aluminum installation case
 casing aluminum+stainless steel / lamping LED 9W / Ra>80 /630LM / Beam 15/30/60 degree / 2700K/3000K/4000K/6000K red / green / blue
 installation supplied with external 100-240V input Ip67 LED driver /check installation in next page

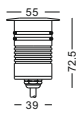

code **GD-ODL031-IN12** Stainless steel 316 cover / aluminum heat sink / aluminum installation case
 casing aluminum+stainless steel / lamping LED 3W / Ra>80 /210LM / Beam 15/30/60 degree / 2700K/3000K/4000K/6000K red / green / blue
 installation supplied with built-in DC 12/24V input LED driver /check installation in next page

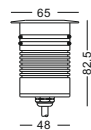

code **GD-ODL032-IN12** Stainless steel 316 cover / aluminum heat sink / aluminum installation case
 casing aluminum+stainless steel / lamping LED 6W / Ra>80 /420LM / Beam 15/30/60 degree / 2700K/3000K/4000K/6000K red / green / blue
 installation supplied with built-in DC 12/24V input LED driver /check installation in next page

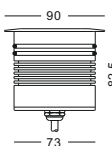

code **GD-ODL033-IN12** Stainless steel 316 cover / aluminum heat sink / aluminum installation case
 casing aluminum+stainless steel / lamping LED 9W / Ra>80 /630LM / Beam 15/30/60 degree / 2700K/3000K/4000K/6000K red / green / blue
 installation supplied with built-in DC 12/24V input LED driver /check installation in next page

GD-ODL031 installation

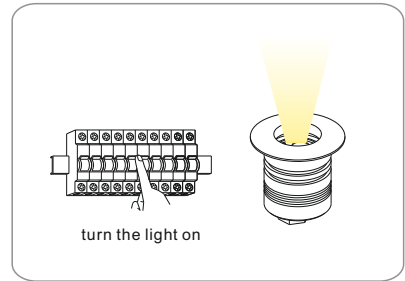
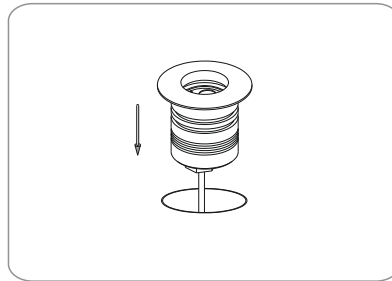
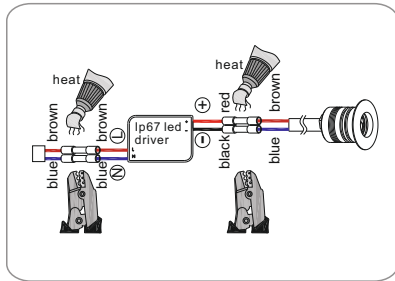
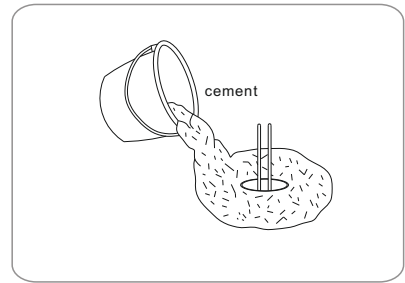
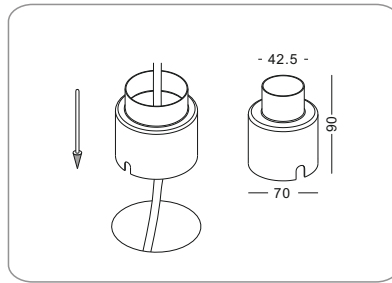
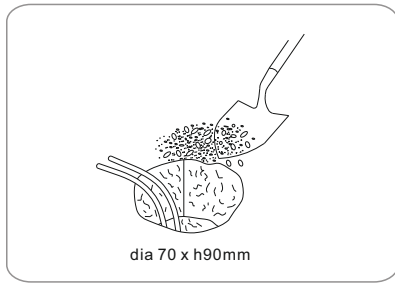

GD-ODL032 / GD-ODL033 installation

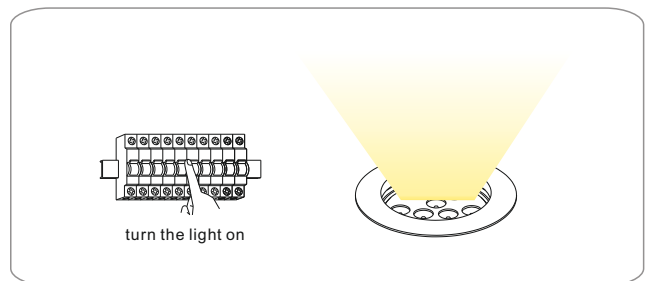
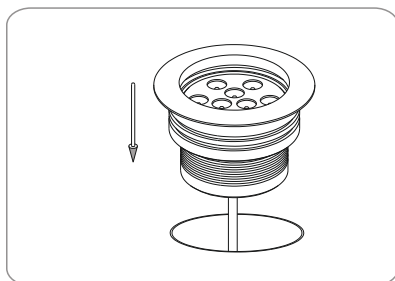
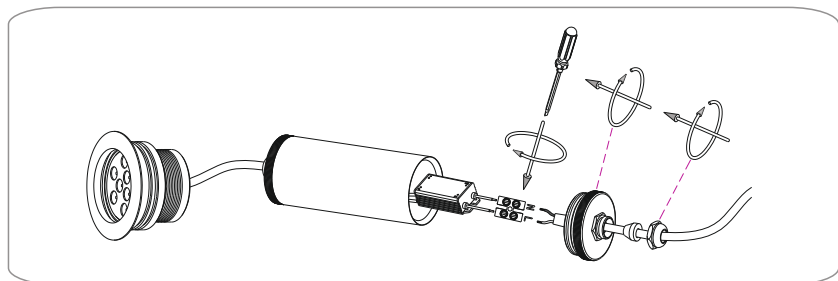
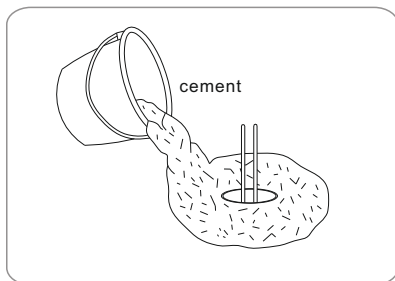
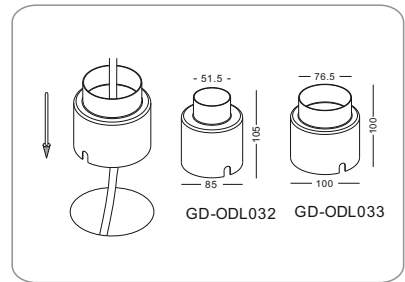
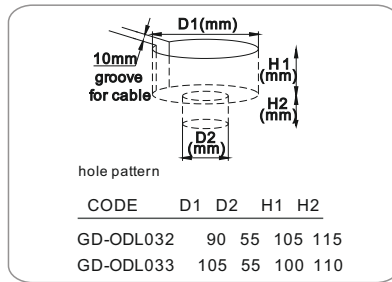
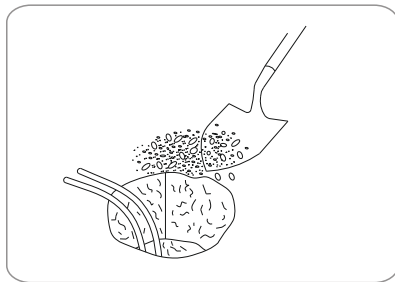

GD-ODL031-IN12 / GD-ODL032-IN12 / GD-ODL033-IN12 installation

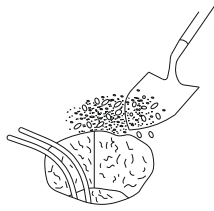

CODE	Diameter	Depth
GD-ODL031-IN12	75mm	90mm
GD-ODL032-IN12	90mm	105mm
GD-ODL033-IN12	105mm	100mm

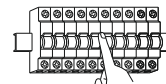
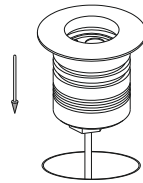
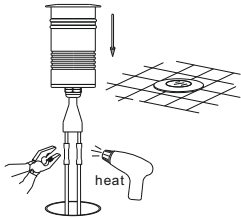
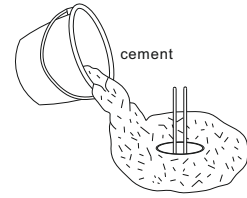
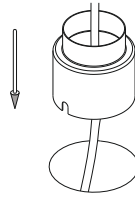

turn the light on



Lamp in a parallel circuit

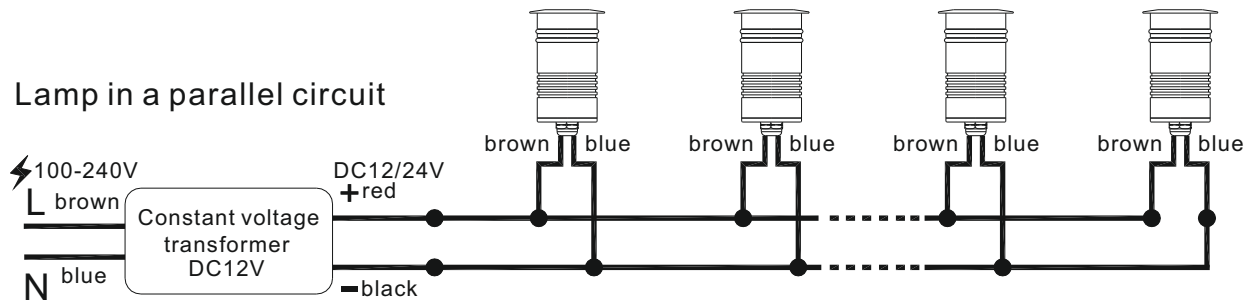

DO NOT CONNECT THE LAMP WHEN THERE IS CIRCUIT IN CASE LED CHIP DAMAGED



DO NOT CONNECT THE LAMP DIRECTLY TO THE MAIN





OUTDOOR UNDERGROUND IP67 WATERPROOF
 MINI LED SPOTLIGHT 220V / DC 12/24V
 STAINLESS STEEL 316 COVER INPUT OPTIONAL
 COPPER LAMP CASING SUPPLIED WITH
 CHROME PLATED INSTALLATION CASE
 1W / 3W LED AND EXTERNAL
 10/20/30/45/60 OR BUILT-IN
 DEGREE LENS POWER-SUPPLY

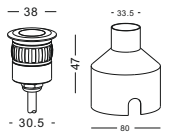

code **GD-ODL020** stainless steel 316 cover / brass heat sink / aluminum installation case
 casing stainless steel+brass / lamping LED 1W / Ra>80 / 70LM / Beam 10/20/30 degree / 2700K/3000K/4000K/6000K
 red / green / blue /
 installation IP67 supplied with external 100-240V input Ip67 LED driver /check installation in next page

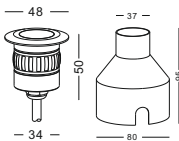

code **GD-ODL024** stainless steel 316 cover / brass heat sink / aluminum installation case
 casing stainless steel+brass / lamping LED 3W / Ra>80 / 120LM / Beam 15/30/45/60 degree / 2700K/3000K/4000K/
 6000K/red / green / blue
 installation IP67 supplied with external 100-240V input Ip67 LED driver /check installation in next page

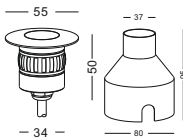

code **GD-ODL001** aluminum cover / aluminum heat sink / aluminum installation case
 casing aluminum / lamping LED 3W / Ra>80 / 120LM / Beam 15/30/45/60 degree / 2700K/3000K/4000K/6000K
 red / green / blue / RGB
 installation IP67 supplied with external 100-240V input Ip67 LED driver /check installation in next page

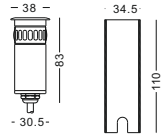

code **GD-ODL020-IN12** stainless steel 316 cover / aluminum heat sink / aluminum installation case
 casing stainless steel+aluminum/ lamping LED 1W / Ra>80 /70LM / Beam 10/20/30 degree / 2700K/3000K/4000K/6000K/red / green / blue
 installation **CE IP67** supplied with built-in DC 12/24V input LED driver /check installation in next page

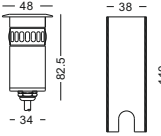

code **GD-ODL024-IN12** stainless steel 316 cover / brass heat sink / aluminum installation case
 casing stainless steel+aluminum/ lamping LED 3W / Ra>80 /120LM / Beam 15/30/45/60 degree / 2700K/3000K/4000K/6000K/red / green / blue
 installation **CE IP67** supplied with built-in DC 12/24V input LED driver /check installation in next page

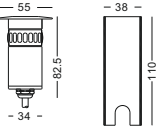

code **GD-ODL001-IN12** aluminum cover / aluminum heat sink / aluminum installation case
 casing aluminum / lamping LED 3W / Ra>80 /120LM / Beam 15/30/45/60 degree /2700K/3000K/4000K/6000K/red / green / blue / RGB
 installation **CE IP67** supplied with built-in DC 12/24V input LED driver /check installation in next page



GD-ODL020 / GD-ODL024 / GD-ODL001 installation

GD-ODL020 / GD-ODL024 / GD-ODL001 Single lamp installation

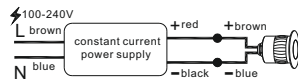

300mA 1x1W for GD-ODL020
600mA 1x3W for GD-ODL024/GD-ODL001

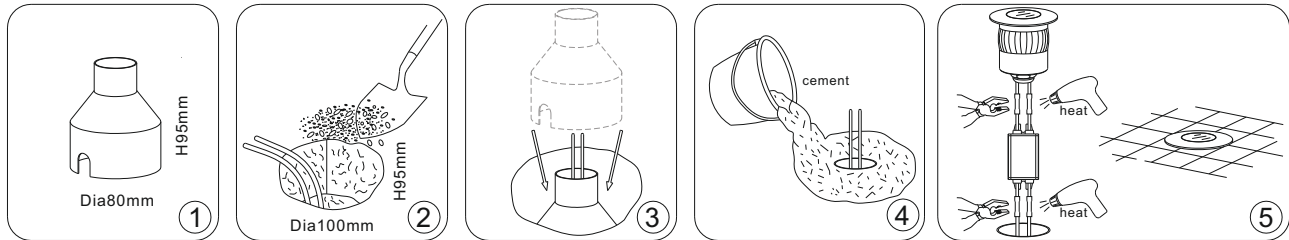

GD-ODL024 / GD-ODL001 Installation in series

lamps in a series circuit

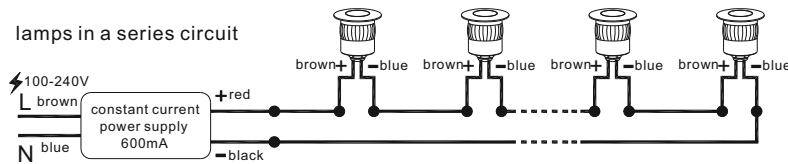

Constant current power supply			
Power supply	Out put current	Out put voltage	Load
2-3x 3W	600mA	DC5-12V	2-3pcs
4-6x 3W	600mA	DC12-22V	4-6pcs
6-10x 3W	600mA	DC20-36V	6-10pcs
10-14x 3W	600mA	DC30-50V	10-14pcs

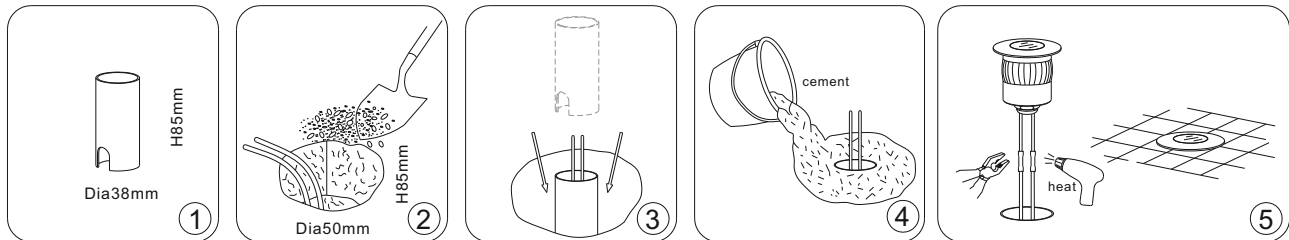

GD-ODL020 Installation in series

lamps in a series circuit

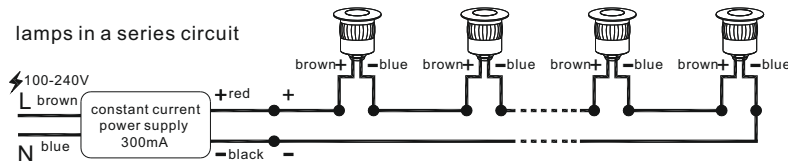

Constant current power supply			
Power supply	Out put current	Out put voltage	Load
1-3x1W	300mA	DC3-11V	1-3pcs
4-7x1W	300mA	DC12-25V	4-7pcs
7-12x1W	300mA	DC20-43V	7-12pcs
12-20x1W	300mA	DC36-72V	12-20pcs
18-28x1W	300mA	DC50-100V	18-28pcs

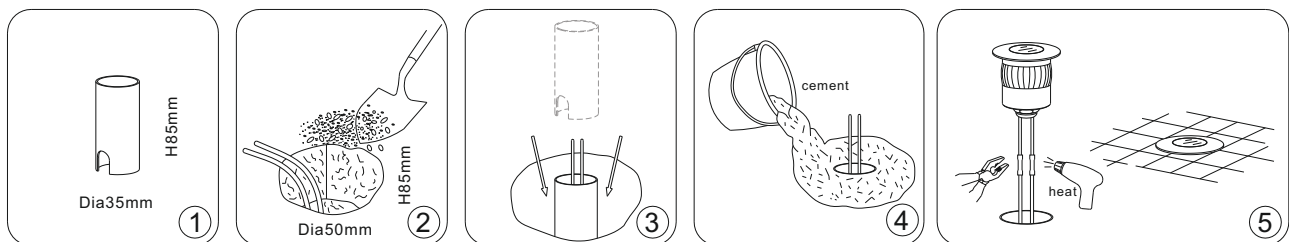

GD-ODL020-IN12 / GD-ODL024-IN12 / GD-ODL001-IN12 installation

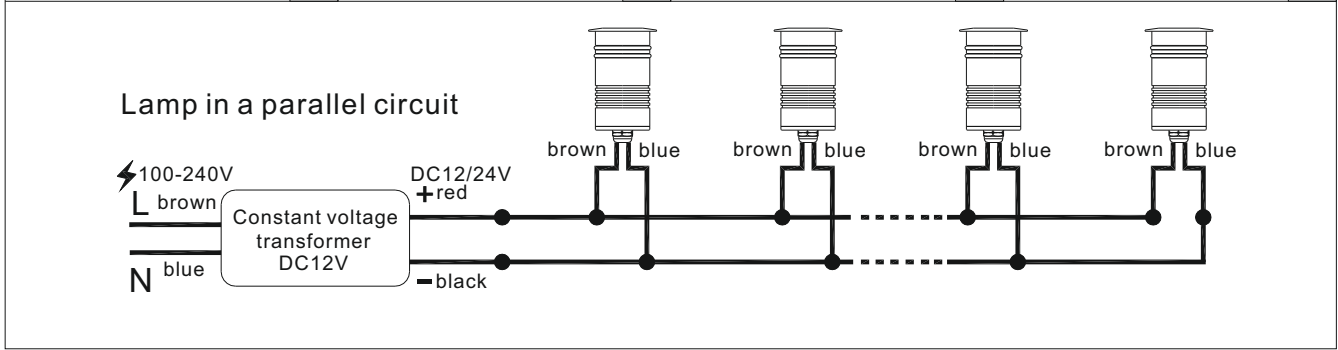
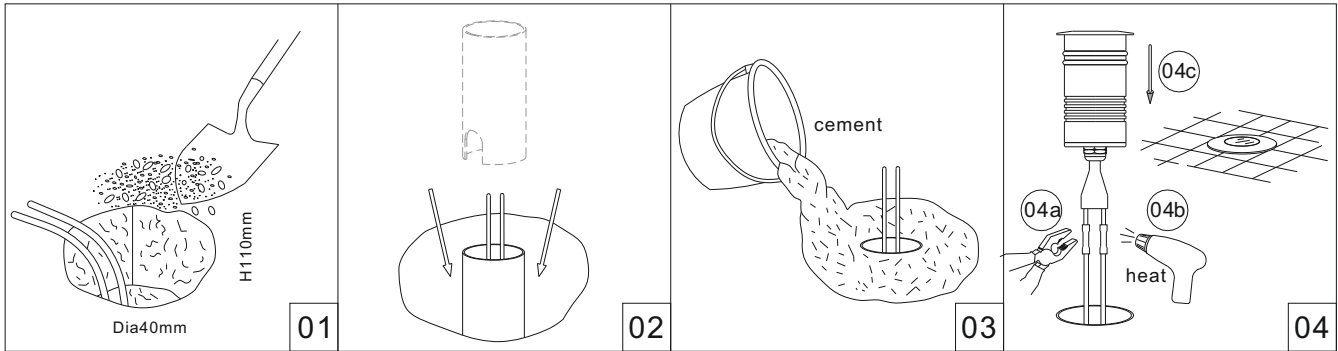

DO NOT CONNECT THE LAMP DIRECTLY TO THE MAIN

STAINLESS STEEL HIGH POWER LED UNDERGROUND SPOT LIGHT

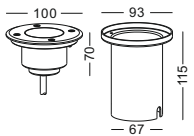

code **GD-ODL028** Stainless steel 316 cover / aluminum heat sink / aluminum installation case
 casing stainless steel+ aluminum lamping COB 5W / Ra>90 / 430LM / Beam15/24/38/60 degree / 2700K/3000K/4000K/6000K
 installation IP67 supplied with external 100-240V input Ip67 LED driver /check installation in next page

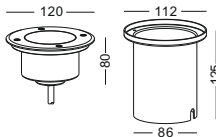

code **GD-ODL029** Stainless steel 316 cover / aluminum heat sink / aluminum installation case
 casing stainless steel+ aluminum lamping COB 9W / Ra>90 / 800LM / Beam15/24/38/60 degree / 2700K/3000K/4000K/6000K
 installation IP67 supplied with external 100-240V input Ip67 LED driver /check installation in next page

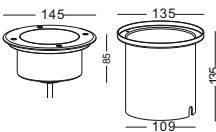

code **GD-ODL030** Stainless steel 316 cover / aluminum heat sink / aluminum installation case
 casing stainless steel+ aluminum lamping COB 12W / Ra>90 / 900LM / Beam15/24/38/60 degree / 2700K/3000K/4000K/6000K
 installation IP67 supplied with external 100-240V input Ip67 LED driver /check installation in next page

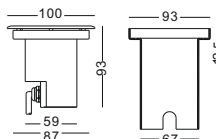

code **GD-ODL028-IN12** Stainless steel 316 cover / aluminum heat sink / aluminum installation case
 casing stainless steel+ aluminum lamping COB 5W / Ra>90 / 430LM / Beam15/24/38/60 degree / 2700K/3000K/4000K/6000K
 installation IP67 supplied with built-in DC 12/24V input LED driver /check installation in next page

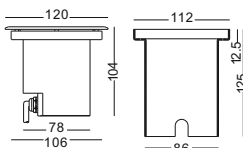

code **GD-ODL029-IN12** Stainless steel 316 cover / aluminum heat sink / aluminum installation case
 casing stainless steel+ aluminum lamping COB 9W / Ra>90 / 800LM / Beam15/24/38/60 degree / 2700K/3000K/4000K/6000K
 installation IP67 supplied with built-in DC 12/24V input LED driver /check installation in next page

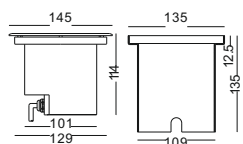

code **GD-ODL030-IN12** Stainless steel 316 cover / aluminum heat sink / aluminum installation case
 casing stainless steel+ aluminum lamping COB 12W / Ra>90 / 900LM / Beam15/24/38/60 degree / 2700K/3000K/4000K/6000K
 installation IP67 supplied with built-in DC 12/24V input LED driver /check installation in next page

GD-ODL028 / GD-ODL029 / GD-ODL030 installation

	D1	D2	H1	H2
GD-ODL-028	88	55	115	95
GD-ODL-029	117	55	125	95
GD-ODL-030	140	55	135	90

GD-ODL028-IN12 / GD-ODL029-IN12 / GD-ODL030-IN12 installation

GD-ODL-028 D98 H115 mm
 GD-ODL-029 D117 H125mm
 GD-ODL-030 D140 H135mm

Lamp in a parallel circuit



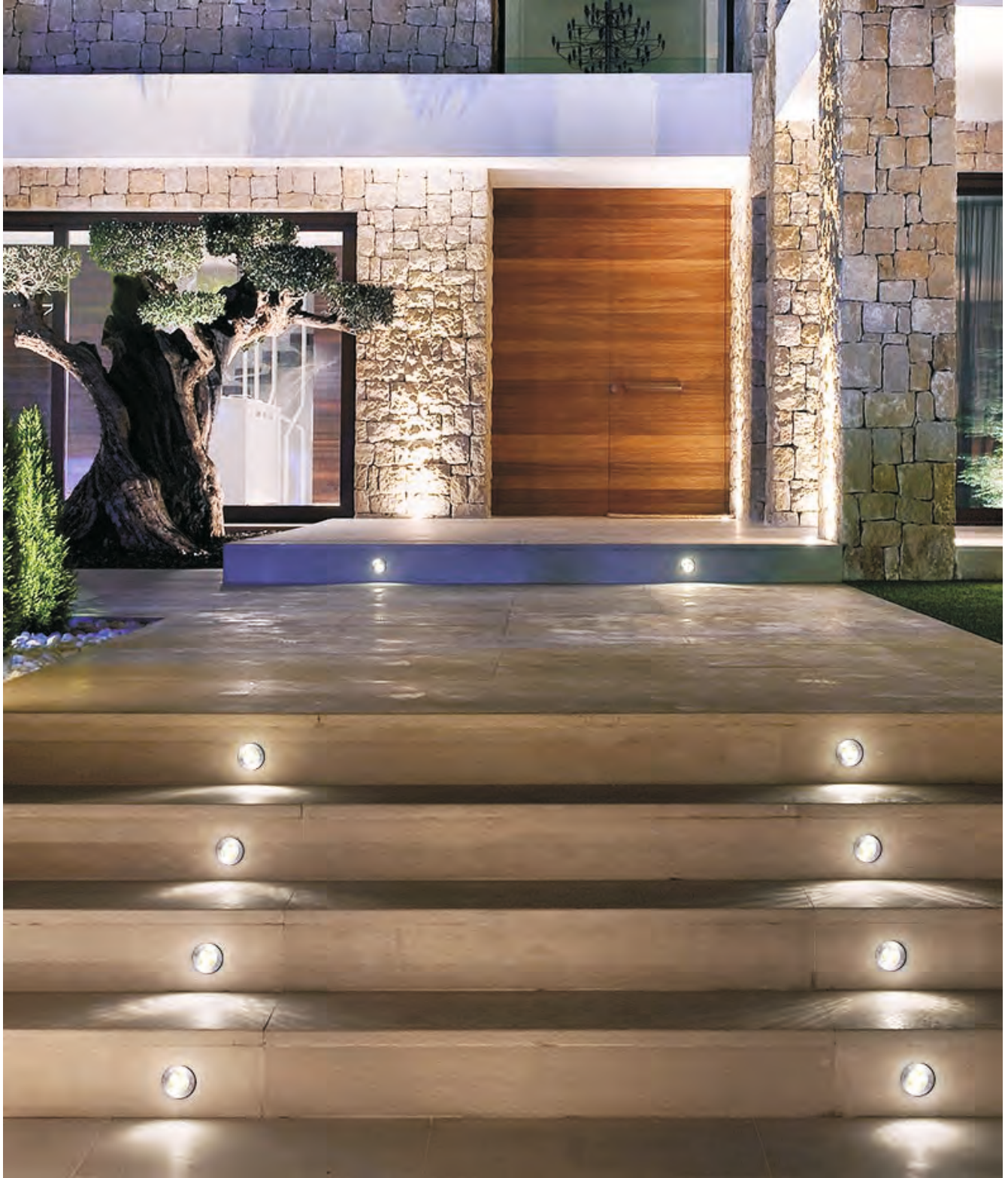



ALL BRASS MADE
OUTDOOR
LIGHT
WALL / SPIKE
CEILING
UNDERGROUND

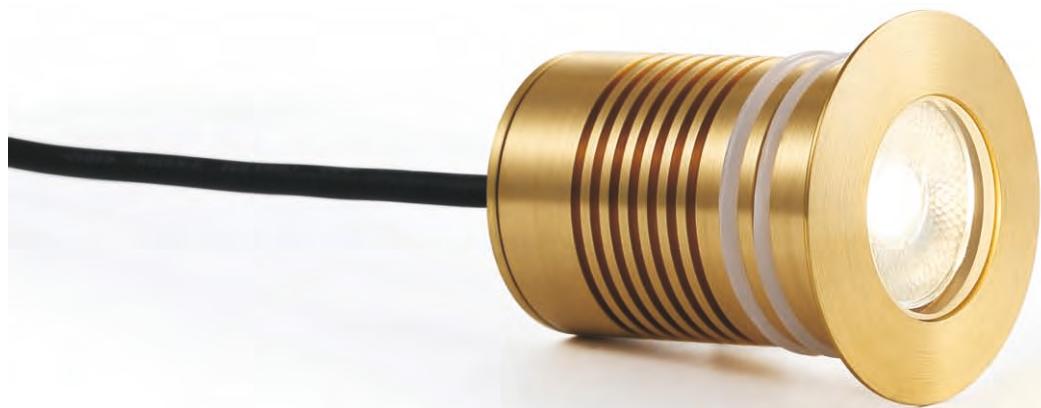

1 2 V / 2 4 V / 2 2 0 V I N P U T U N D E R G R O U N D S P O T L I G H T

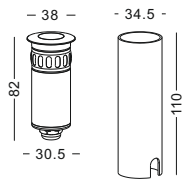

code **GD-ODL047-IN220**
 casing all in brass / polished
 lamping LED 1W / Ra>80 / 70LM
 Beam 30 degree /
 2700K/3000K/4000K/6000K
 input voltage 100-240V
 installation **CE IP67**

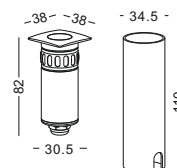

code **GD-ODL047A-IN220**
 casing all in brass / polished
 lamping LED 1W / Ra>80 / 70LM
 Beam 30 degree /
 2700K/3000K/4000K/6000K
 input voltage 100-240V
 installation **CE IP67**

code **GD-ODL047-IN12**
 input voltage 12/24V
 installation **CE IP67**

code **GD-ODL047A-IN12**
 input voltage 12/24V
 installation **CE IP67**

installation guide

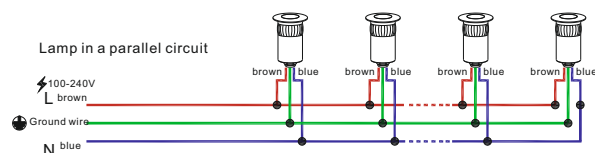
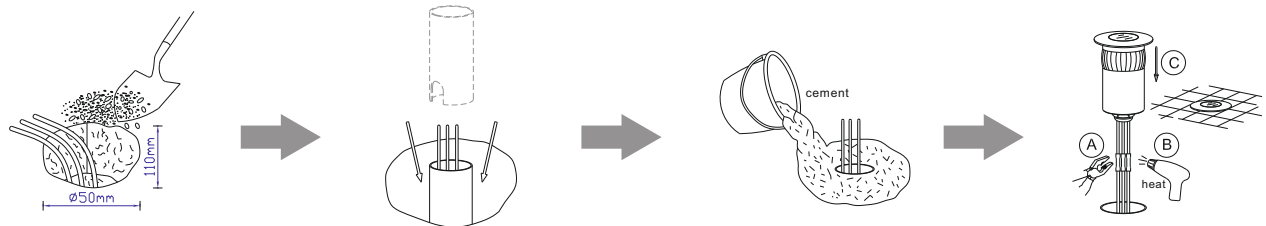

100-240V input

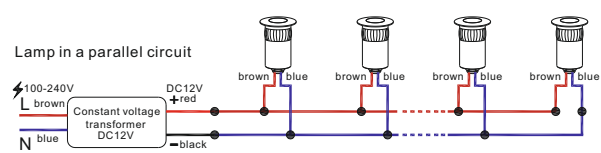

DC 12V input



1 2 V / 2 4 V / 2 2 0 V I N P U T U N D E R G R O U N D S P O T L I G H T

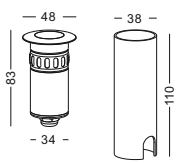

code **GD-ODL048-IN220**
 casing all in brass / polished
 lamping LED 3W / Ra>80 / 120LM
 Beam 30 degree /
 2700K/3000K/4000K/6000K
 input voltage 100-240V
 installation **CE IP67**

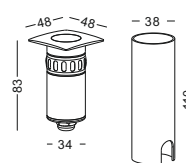

code **GD-ODL048A-IN220**
 casing all in brass / polished
 lamping LED 3W / Ra>80 / 120LM
 Beam 30 degree /
 2700K/3000K/4000K/6000K
 input voltage 100-240V
 installation **CE IP67**

code **GD-ODL048-IN12**
 input voltage 12/24V
 installation **CE IP67**

code **GD-ODL048A-IN12**
 input voltage 12/24V
 installation **CE IP67**

installation guide

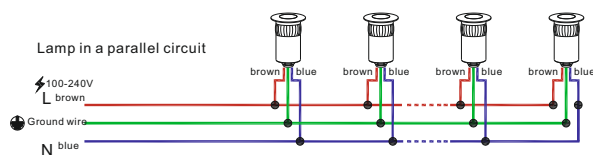
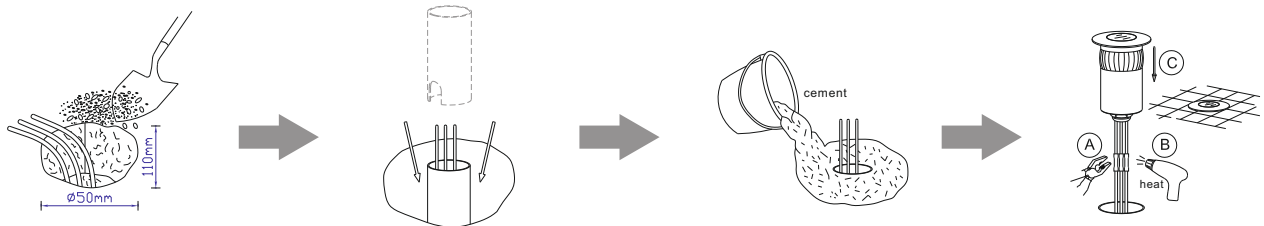

100-240V input

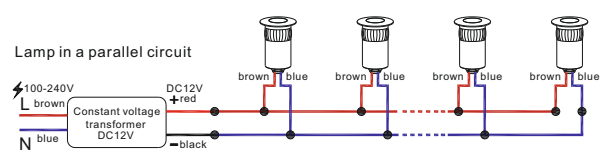

DC 12V input



12V / 24V / 220V INPUT UNDERGROUND SPOTLIGHT

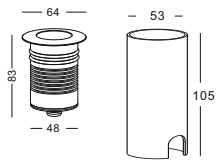

code **GD-ODL049-IN220**
 casing all in brass / polished
 lamping COB 5W / Ra>90 / 430LM
 Beam 10 / 20 / 30 degree /
 2700K/3000K/4000K/6000K
 input voltage 100-240V
 installation **CE IP67**

code **GD-ODL049-IN12**
 input voltage 12/24V
 installation **CE IP67**

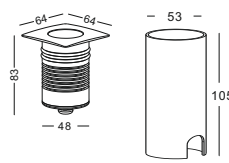

code **GD-ODL049A-IN220**
 casing all in brass / polished
 lamping COB 5W / Ra>90 / 430LM
 Beam 10 / 20 / 30 degree /
 2700K/3000K/4000K/6000K
 input voltage 100-240V
 installation **CE IP67**

code **GD-ODL049A-IN12**
 input voltage 12/24V
 installation **CE IP67**

installation guide

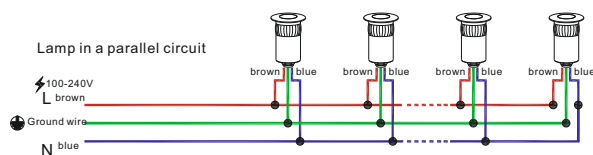
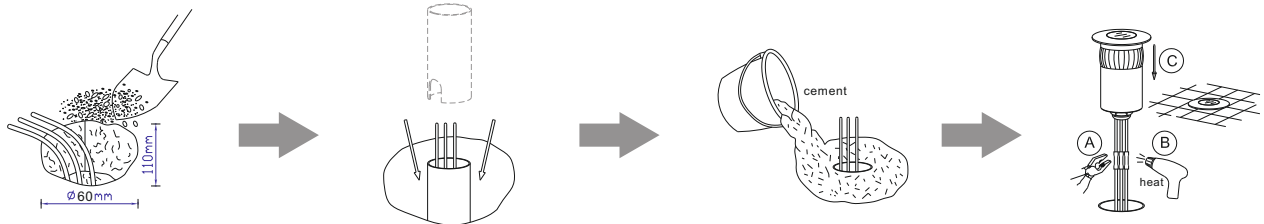
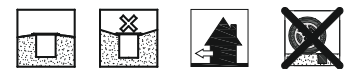

100-240V input

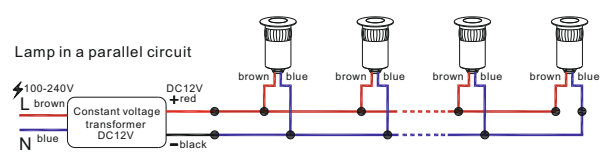

DC 12V input



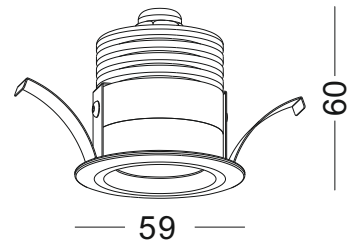
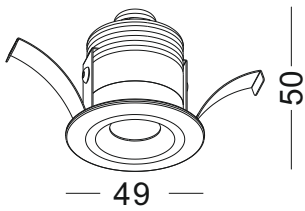

code **GD-LDC402**
 casing all in brass
 finishing polished
 lamping LED 3W
 lumens 120LM
 CRI Ra>80
 Beam 30 degree
 2700K/3000K/4000K/6000K
 input voltage 100-240V
 installation   **CE** IP67
 cut-off dia43mm

code **GD-LDC403**
 casing all in brass
 finishing polished
 lamping COB 6W /
 lumens 500LM
 CRI Ra>90
 Beam 10 / 20 / 30 degree /
 2700K/3000K/4000K/6000K
 input voltage 100-240V
 installation   **CE** IP67
 cut-off dia53mm

12V / 24V / 220V INPUT ALL BRASS MADE SPIKE GARDEN LIGHT

Ip67 WATERPROOF
220V / DC12/24V
INPUT OPTIONAL
BUILT-IN
POWER-SUPPLY
ALL BRASS MADE

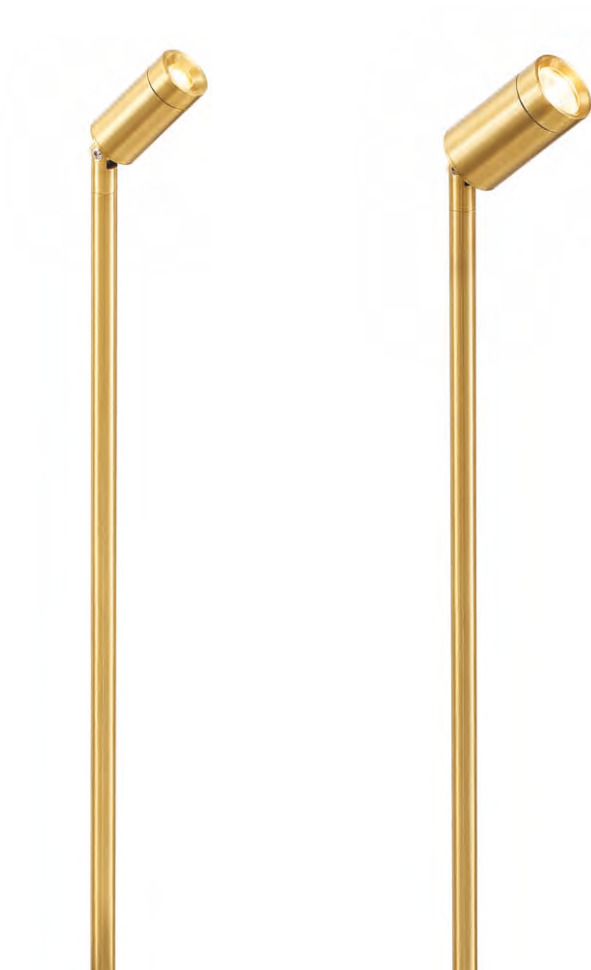
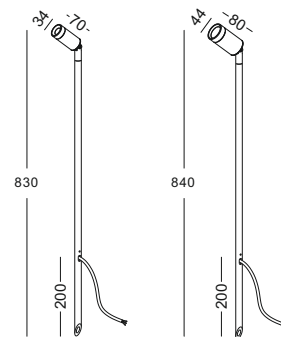

code [GD-LFL036-IN220](#)

casing all in brass

finishing polished

lamping LED 3W / Ra>80 / 120LM

Beam 30 degree /

2700K/3000K/4000K/6000K

installation   IP65

100-240V input

code [GD-LFL036-IN12](#)

installation   CE IP65

DC 12/24V input

code [GD-LFL037-IN220](#)

casing all in brass

finishing polished

lamping COB 5W / Ra>90 / 430LM

Beam 10 / 20 / 30 degree /

2700K/3000K/4000K/6000K

installation   IP65

100-240V input

code [GD-LFL037-IN12](#)

installation   CE IP65

DC 12/24V input

OUTDOOR SPOT LIGHT WITH SPIKE

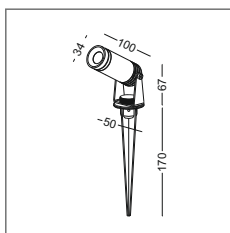

surface
customizable

■ concrete grey paint
similar to RAL7037

code **GD-LSP183-IN220**

casing aluminum

finishing black painting

lamping LED 3W

Lumens 120LM

CRI Ra>80

Beam 10/20/30 degree

led color 2700K/3000K/4000K/6000K

RED / GREEN / BLUE

Input AC220-240V

built-in power-supply

installation    IP65

code **GD-LSP183-IN12**

Input DC12/24V

built-in power-supply

installation in parallel

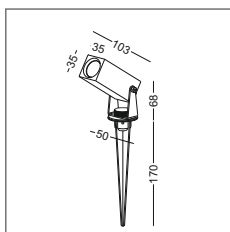

surface
customizable

■ concrete grey paint
similar to RAL7037

code **GD-LSP187-IN220**

casing aluminum

finishing black painting

lamping LED 3W

Lumens 120LM

CRI Ra>80

Beam 10/20/30 degree

led color 2700K/3000K/4000K/6000K

RED / GREEN / BLUE

Input AC220-240V

built-in power-supply

installation    IP65

code **GD-LSP187-IN12**

Input DC12/24V

built-in power-supply

installation in parallel



OUTDOOR SPOT LIGHT WITH SPIKE

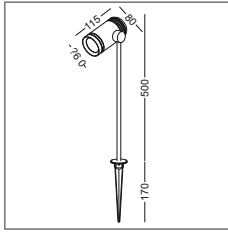

surface
customizable

■ concrete grey paint
similar to RAL7037

code **GD-LFL027-IN220**

casing aluminum

finishing black painting

lamping COB 6W

Lumens 500LM

CRI Ra>90

Beam 15/24/38/60 degree

led color 2700K/3000K/4000K/6000K

Input AC220-240V

built-in power-supply

installation    IP65

code **GD-LFL027-IN12**

Input DC12/24V

built-in power-supply

installation in parallel

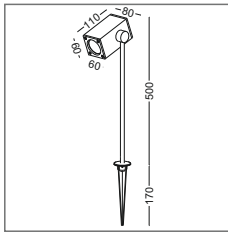

surface
customizable

■ concrete grey paint
similar to RAL7037

code **GD-LFL028-IN220**

casing aluminum

finishing black painting

lamping COB 6W

Lumens 500LM

CRI Ra>90

Beam 15/24/38/60 degree

led color 2700K/3000K/4000K/6000K

Input AC220-240V

built-in power-supply

installation    IP65

code **GD-LFL028-IN12**

Input DC12/24V

built-in power-supply

installation in parallel



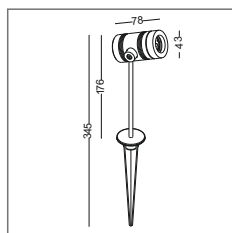

OUTDOOR SPOT LIGHT WITH SPIKE



surface
customizable

■ concrete grey paint
similar to RAL7037

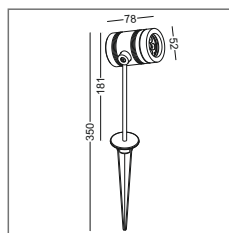

code **GD-ODL034**
 casing aluminum
 finishing black painting
 lamping LED 3X1W
 Lumens 210LM
 CRI Ra>80
 Beam 15/30/60 degree
 led color 2700K/3000K/4000K/6000K
 RED / GREEN / BLUE
 Input AC220-240V
 external power-supply
 installation    IP65

code **GD-ODL034-12V**
 Input DC12/24V
 external power-supply
 installation in parallel



surface
customizable

■ concrete grey paint
similar to RAL7037

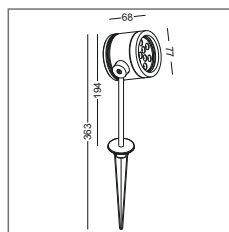

code **GD-ODL035**
 casing aluminum
 finishing black painting
 lamping LED 6X1W
 Lumens 420LM
 CRI Ra>80
 Beam 15/30/60 degree
 led color 2700K/3000K/4000K/6000K
 RED / GREEN / BLUE
 Input AC220-240V
 external power-supply
 installation    IP65

code **GD-ODL035-12V**
 Input DC12/24V
 external power-supply
 installation in parallel



surface
customizable

■ concrete grey paint
similar to RAL7037



code **GD-ODL036**
 casing aluminum
 finishing black painting
 lamping LED 9X1W
 Lumens 630LM
 CRI Ra>80
 Beam 15/30/60 degree
 led color 2700K/3000K/4000K/6000K
 RED / GREEN / BLUE
 Input AC220-240V
 external power-supply
 installation    IP65

code **GD-ODL036-12V**
 Input DC12/24V
 external power-supply
 installation in parallel



OUTDOOR SPOT LIGHT WITH SPIKE



code **GD-LSP155**

casing aluminum
 finishing black painting
 lamping COB 6W
 Lumens 500LM
 CRI Ra>90
 Beam 15/24/38/60 degree
 led color 2700K/3000K/4000K/6000K
 Input AC220-240V
 external power-supply
 installation    IP65

code **GD-LSP155-12V**

Input DC12/24V
 external power-supply
 installation in parallel

code **GD-LSP156**

casing aluminum
 finishing black painting
 lamping COB 9W
 Lumens 800LM
 CRI Ra>90
 Beam 15/24/38/60 degree
 led color 2700K/3000K/4000K/6000K
 Input AC220-240V
 external power-supply
 installation    IP65

code **GD-LSP156-12V**

Input DC12/24V
 external power-supply
 installation in parallel

code **GD-LSP157**

casing aluminum
 finishing black painting
 lamping COB 12W
 Lumens 900LM
 CRI Ra>90
 Beam 15/24/38/60 degree
 led color 2700K/3000K/4000K/6000K
 Input AC220-240V
 external power-supply
 installation    IP65

code **GD-LSP157-12V**

Input DC12/24V
 external power-supply
 installation in parallel

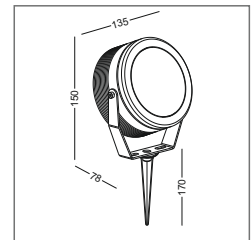
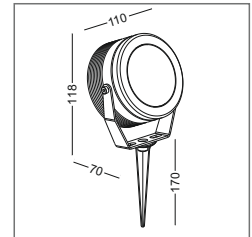
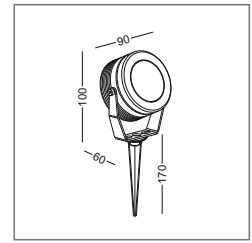

surface customizable

 concrete grey paint similar to RAL7037



OUTDOOR SPOT LIGHT WITH SPIKE

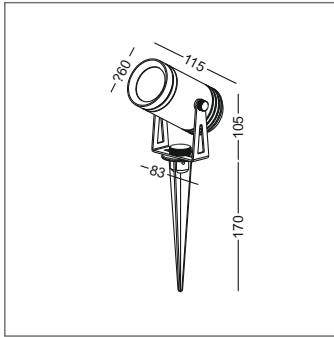

code **GD-LSP184-IN220**
 casing aluminum
 finishing black painting
 lamping COB 6W
 Lumens 500LM
 CRI Ra>90
 Beam 15/24/38/60 degree
 led color 2700K/3000K/4000K/6000K
 Input AC220-240V
 built-in power-supply
 installation IP65

code **GD-LSP184-IN12**
 Input DC12/24V
 built-in power-supply
 installation in parallel

surface customizable
 concrete grey paint similar to RAL7037

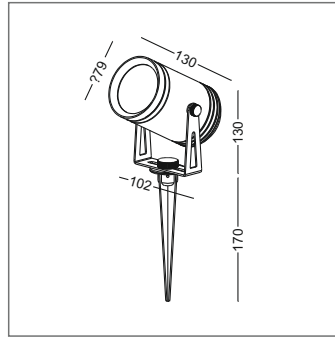

code **GD-LSP185-IN220**
 casing aluminum
 finishing black painting
 lamping COB 9W
 Lumens 800LM
 CRI Ra>90
 Beam 15/24/38/60 degree
 led color 2700K/3000K/4000K/6000K
 Input AC220-240V
 built-in power-supply
 installation IP65

code **GD-LSP185-IN12**
 Input DC12/24V
 built-in power-supply
 installation in parallel

surface customizable
 concrete grey paint similar to RAL7037

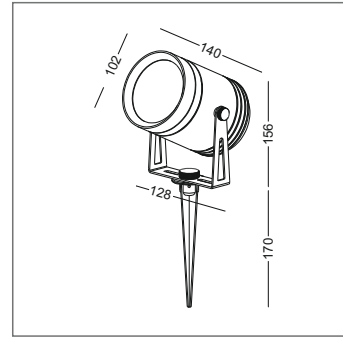

code **GD-LSP186-IN220**
 casing aluminum
 finishing black painting
 lamping COB 12W
 Lumens 900LM
 CRI Ra>90
 Beam 15/24/38/60 degree
 led color 2700K/3000K/4000K/6000K
 Input AC220-240V
 built-in power-supply
 installation IP65

code **GD-LSP186-IN12**
 Input DC12/24V
 built-in power-supply
 installation in parallel

surface customizable
 concrete grey paint similar to RAL7037



OUTDOOR SPOT LIGHT WITH SPIKE

code **GD-LSP188-IN220**

casing aluminum

finishing black painting

lamping COB 6W

Lumens 500LM

CRI Ra>90

Beam 15/24/38/60 degree

led color 2700K/3000K/4000K/6000K

Input AC220-240V

built-in power-supply

installation    IP65

code **GD-LSP188-IN12**

Input DC12/24V

built-in power-supply

installation in parallel

code **GD-LSP189-IN220**

casing aluminum

finishing black painting

lamping COB 12W

Lumens 900LM

CRI Ra>90

Beam 15/24/38/60 degree

led color 2700K/3000K/4000K/6000K

Input AC220-240V

built-in power-supply

installation    IP65

code **GD-LSP189-IN12**

Input DC12/24V

built-in power-supply

installation in parallel

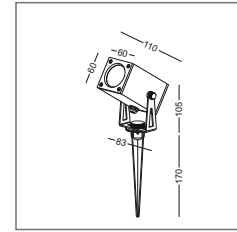

surface
customizable

 concrete grey paint
similar to RAL7037

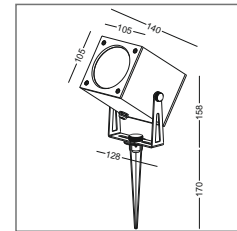

surface
customizable

 concrete grey paint
similar to RAL7037



LED GARDEN AND PATH LIGHTS



LED GARDEN AND PATH LIGHTS

code **GD-LFL006**
GD-LFL007
GD-LFL008

casing aluminum
 finishing black painting
 lamping COB 6W
 Lumens 500LM
 CRI Ra>90
 Beam Solid acrylic diffuser
 led color 2700K/3000K/4000K/6000K
 Input AC100-240V
 built-in power-supply
 installation   IP65

code **GD-LFL006-IN12**
GD-LFL007-IN12
GD-LFL008-IN12

Input DC12/24V
 built-in power-supply
 installation in parallel

surface customizable
 concrete grey paint similar to RAL7037

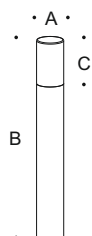
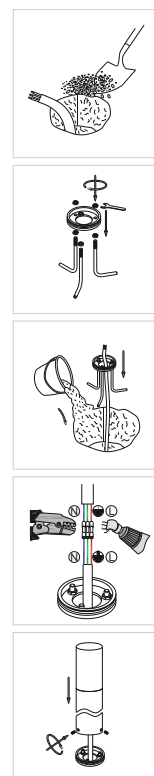

code	A/mm	B/mm	C/mm
GD-LFL006	60	450	100
GD-LFL007	60	650	100
GD-LFL007	60	800	100



LED GARDEN AND PATH LIGHTS

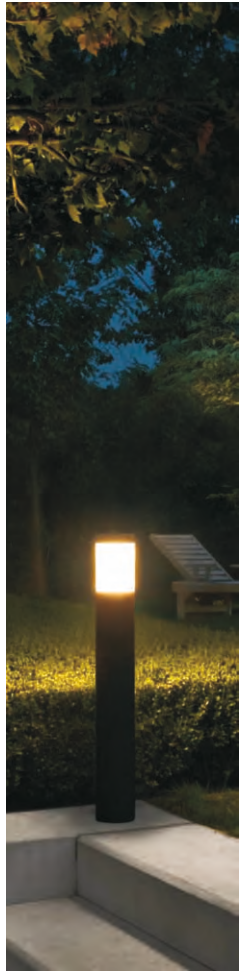

code **GD-LFL009**
GD-LFL010
GD-LFL011

casing aluminum
 finishing black painting
 lamping COB 9W
 Lumens 800LM
 CRI Ra>90
 Beam Solid acrylic diffuser
 led color 2700K/3000K/4000K/6000K
 Input AC100-240V
 built-in power-supply
 installation    IP65

code **GD-LFL009-IN12**
GD-LFL010-IN12
GD-LFL011-IN12

Input DC12/24V
 built-in power-supply
 installation in parallel

surface customizable
 concrete grey paint similar to RAL7037

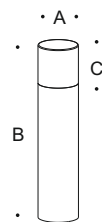
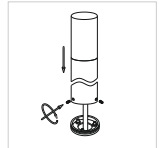
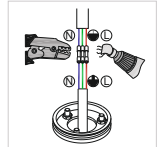
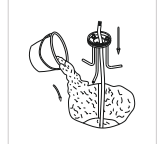

code	A/mm	B/mm	C/mm
GD-LFL009	102	210	60
GD-LFL010	102	410	60
GD-LFL011	102	610	60



LED GARDEN AND PATH LIGHTS

code **GD-LFL020**

GD-LFL021

casing aluminum

finishing black painting

lamping E14 socket

Supplied with
4W led candle lamp

Lumens 360LM

CRI Ra>80

Beam Acrylic diffuser

lamp color 2700K/3000K/4000K/6000K

Input AC100-240V

lamp inside changeable

installation   IP65

surface

customizable

 concrete grey paint
similar to RAL7037

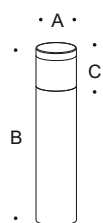
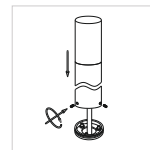
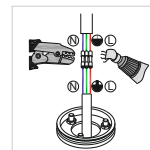
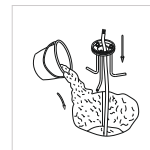
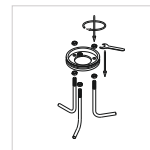

code	A/mm	B/mm	C/mm
GD-LFL020	60	700	100
GD-LFL021	80	700	130

LED GARDEN AND PATH LIGHTS

code **GD-LFL022**
GD-LFL023
GD-LFL024

casing aluminum
 finishing black painting
 lamping E27 socket
 Supplied with
 4W led candle lamp

Lumens 360LM
 CRI Ra>80
 Beam Acrylic diffuser
 lamp color 2700K/3000K/4000K/6000K
 Input AC100-240V
 lamp inside changeable

installation    IP65

surface customizable
 concrete grey paint similar to RAL7037

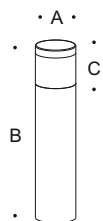
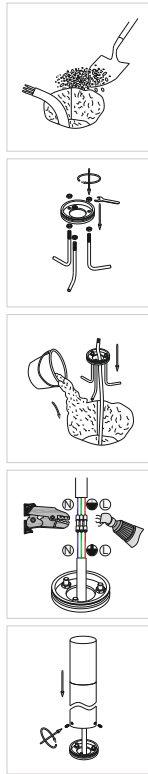

code	A/mm	B/mm	C/mm
GD-LFL022	102	350	150
GD-LFL023	102	550	150
GD-LFL024	102	750	150



LED GARDEN AND PATH LIGHTS

code **GD-LFL013**
GD-LFL014
GD-LFL015

code **GD-LFL013-IN12**
GD-LFL014-IN12
GD-LFL015-IN12

casing aluminum
 finishing black painting
 lamping COB 6W
 Lumens 500LM
 CRI Ra>90
 Beam Solid acrylic diffuser
 led color 2700K/3000K/4000K/6000K
 Input AC100-240V
 built-in power-supply
 installation   IP65

Input DC12/24V
 built-in power-supply
 installation in parallel

surface customizable
 concrete grey paint similar to RAL7037

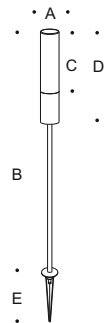
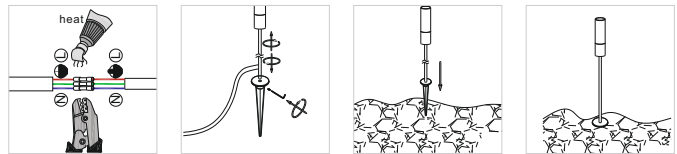

code	A/mm	B/mm	C/mm	D/mm	E/mm
GD-LFL013	60	820	200	320	207
GD-LFL014	60	1020	200	320	207
GD-LFL015	60	1220	200	320	207

LED GARDEN AND PATH LIGHTS

code **GD-LFL016**
GD-LFL017
GD-LFL018

casing aluminum
 finishing black painting
 lamping LED 1W
 Lumens 70LM
 CRI Ra>80
 Beam Solid acrylic diffuser
 led color 2700K/3000K/4000K/6000K

RED / GREEN / BLUE
 Input AC100-240V
 external power-supply

installation    IP65

code **GD-LFL016-12V**
GD-LFL017-12V
GD-LFL018-12V

Input DC12/24V
 external power-supply
 installation in parallel

surface customizable
 concrete grey paint similar to RAL7037

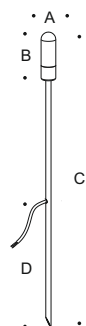



code	A/mm	B/mm	C/mm	D/mm
GD-LFL016	28	90	1000	250
GD-LFL017	28	90	800	250
GD-LFL018	28	90	600	250





LED GARDEN AND PATH LIGHTS

code **GD-LFL030**
GD-LFL031
GD-LFL032

casing aluminum
 finishing black painting
 lamping LED 3W
 Lumens 120LM
 CRI Ra>80
 Beam Solid acrylic diffuser
 led color 2700K/3000K/4000K/6000K
 RED / GREEN / BLUE
 Input AC100-240V
 external power-supply
 installation    IP65

code **GD-LFL030-12V**
GD-LFL031-12V
GD-LFL032-12V

Input DC12/24V
 external power-supply
 installation in parallel

surface customizable
 concrete grey paint similar to RAL7037

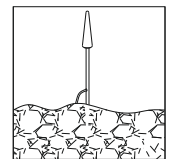
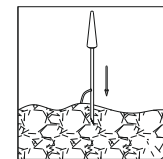
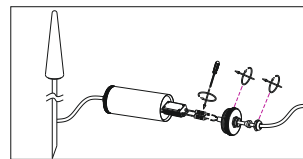

GD-LFL030

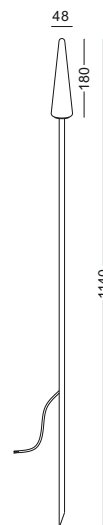

GD-LFL031

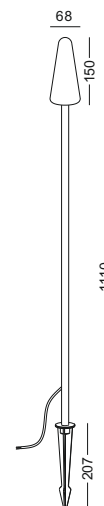

GD-LFL032





12V / 24V / 220V INPUT ALL BRASS MADE SPIKE GARDEN LIGHT

Ip67 WATERPROOF
220V / DC12/24V
INPUT OPTIONAL
BUILT-IN
POWER-SUPPLY
ALL BRASS MADE

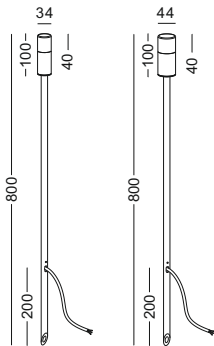

code [GD-LFL034-IN220](#)
casing all in brass
finishing polished
lamping LED 3W / Ra>80 /120LM
Beam acrylic diffuser
2700K/3000K/4000K/6000K
installation    IP65
100-240V input

code [GD-LFL034-IN12](#)
installation    IP65
DC 12/24V input

code [GD-LFL035-IN220](#)
casing all in brass
finishing polished
lamping COB 5W / Ra>90 /430LM
Beam acrylic diffuser
2700K/3000K/4000K/6000K
installation    IP65
100-240V input

code [GD-LFL035-IN12](#)
installation    IP65
DC 12/24V input

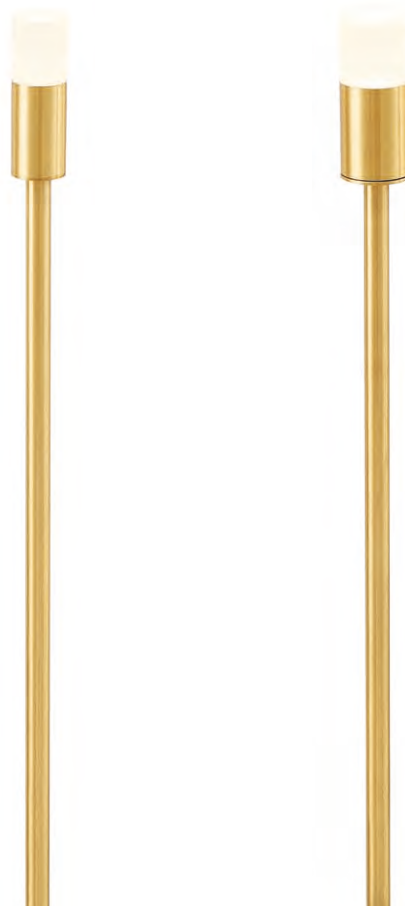



code [GD-LFL038](#)

[GD-LFL039](#)

[GD-LFL040](#)

casing aluminum

finishing black painting

lamping COB 6W

lumens 500LM

CRI Ra>90

Beam acrylic diffuser

2700K/3000K/4000K/6000K

installation     IP65

check manul before
installation

surface customizable  white paint
similar to RAL9003

 concrete grey paint
similar to RAL7037

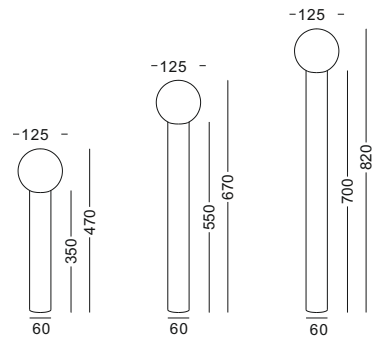

[GD-LFL038](#) [GD-LFL039](#) [GD-LFL040](#)

LED GARDEN AND PATH LIGHTS

code **GD-LFL026**

casing aluminum

finishing black painting

lampping SMD 10W

Lumens 1000LM

CRI Ra>80

Beam Solid acrylic diffuser

led color 2700K/3000K/4000K/6000K

Input AC100-240V

built-in power-supply

installation    IP65

code **GD-LFL026-12V**

Input DC12/24V

built-in power-supply

installation in parallel

surface customizable

 concrete grey paint similar to RAL7037

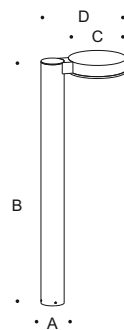
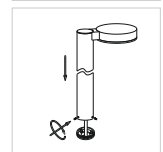
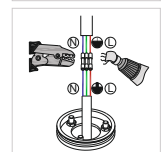
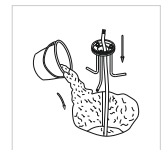

code	A/mm	B/mm	C/mm	D/mm
GD-LFL026	60	700	150	225



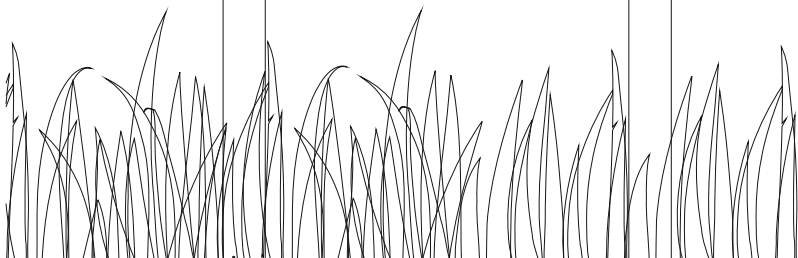
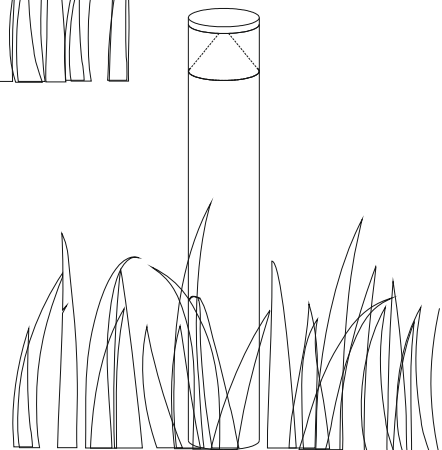
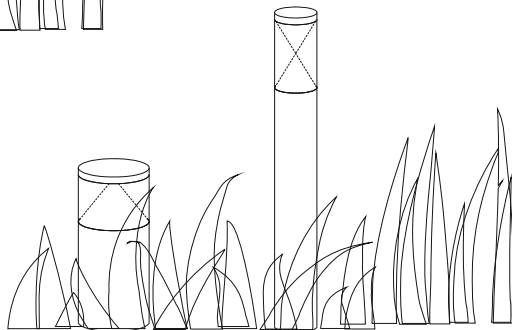
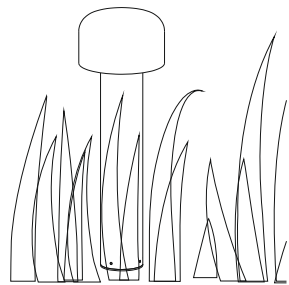
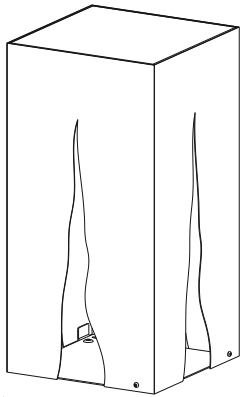
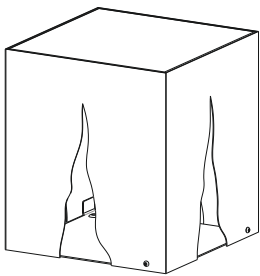

2021 SPRING NEW GARDEN LIGHT





LED GARDEN AND PATH LIGHTS

code **GD-LFL041**
GD-LFL042
GD-LFL043

casing aluminum
 finishing black painting
 lamping COB 6W
 Lumens 500LM
 CRI Ra>90
 Beam Solid acrylic diffuser/
 Laser cut inside and reflect
 and diffuse the light
 led color 2700K/3000K/4000K/6000K
 Input AC100-240V
 built-in power-supply
 installation   IP65

code **GD-LFL041-IN12**
GD-LFL042-IN12
GD-LFL043-IN12

Input DC12/24V
 built-in power-supply
 installation in parallel

surface customizable
 concrete grey paint
 similar to RAL7037

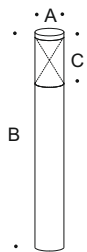
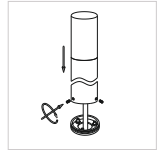
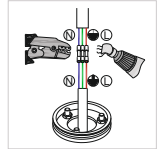
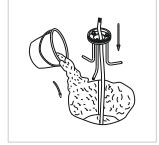
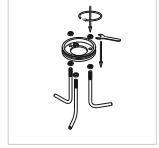

code	A/mm	B/mm	C/mm
GD-LFL041	60	460	110
GD-LFL042	60	660	110
GD-LFL043	60	810	110



LED GARDEN AND PATH LIGHTS

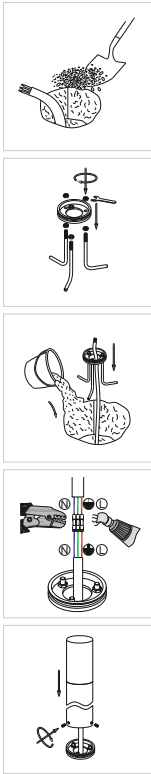

code **GD-LFL044**
GD-LFL045
GD-LFL046

code **GD-LFL044-IN12**
GD-LFL045-IN12
GD-LFL046-IN12

casing aluminum
 finishing black painting
 lamping COB 9W
 Lumens 800LM
 CRI Ra>90
 Beam Solid acrylic diffuser/
 Laser cut inside and reflect
 and diffuse the light
 led color 2700K/3000K/4000K/6000K
 Input AC100-240V
 built-in power-supply
 installation IP65

Input DC12/24V
 built-in power-supply
 installation in parallel

surface customizable
 concrete grey paint similar to RAL7037



code	A/mm	B/mm	C/mm
GD-LFL044	102	230	80
GD-LFL045	102	430	80
GD-LFL046	102	630	80

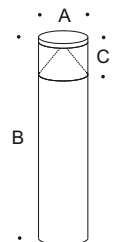



LED GARDEN AND PATH LIGHTS

code **GD-LFL048**

GD-LFL049

casing aluminum

brass shade

finishing black painting

lamping SMD 6W

Lumens 600LM

CRI Ra>80

Beam acrylic diffuser

led color 2700K/3000K/4000K/6000K

Input AC100-240V

built-in power-supply

installation    IP65

code **GD-LFL048-IN12**

GD-LFL049-IN12

Input DC12/24V

built-in power-supply

installation in parallel

surface

customizable

 concrete grey paint
similar to RAL7037

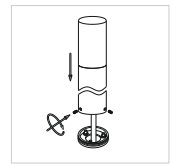
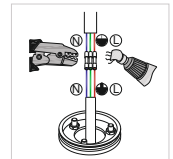
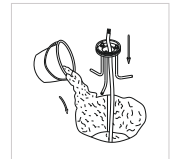

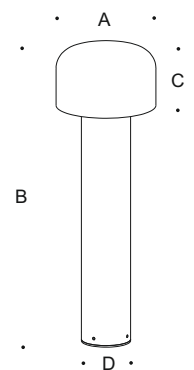

code	A/mm	B/mm	C/mm	D/mm
GD-LFL048	125	380	75	60
GD-LFL049	125	800	75	60











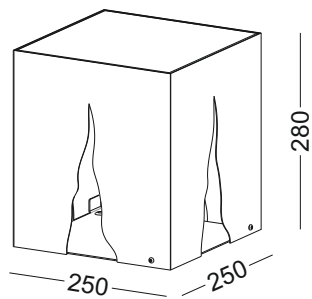

code **GD-LFL050**
 casing stainless steel
 finishing grey painting
 lamping E14 socket
 Supplied with
 4W led candle lamp
 Lumens 360LM
 CRI Ra>80
 Beam laser cut shape
 lamp color 2700K/3000K/4000K/6000K
 Input AC220-240V
 lamp inside changeable
 installation    IP65

surface
 customizable
 black paint
 equal to RAL9011



code **GD-LFL051**
 casing stainless steel
 finishing grey painting
 lamping E14 socket
 Supplied with
 4W led candle lamp
 Lumens 360LM
 CRI Ra>80
 Beam laser cut shape
 lamp color 2700K/3000K/4000K/6000K
 Input AC220-240V
 lamp inside changeable
 installation    IP65

surface
 customizable
 black paint
 equal to RAL9011

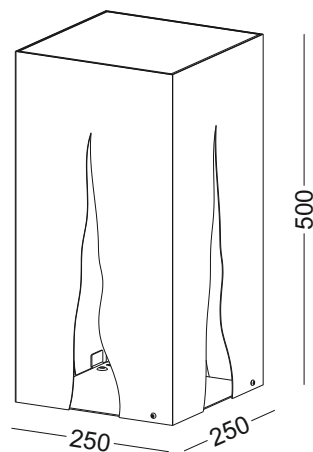



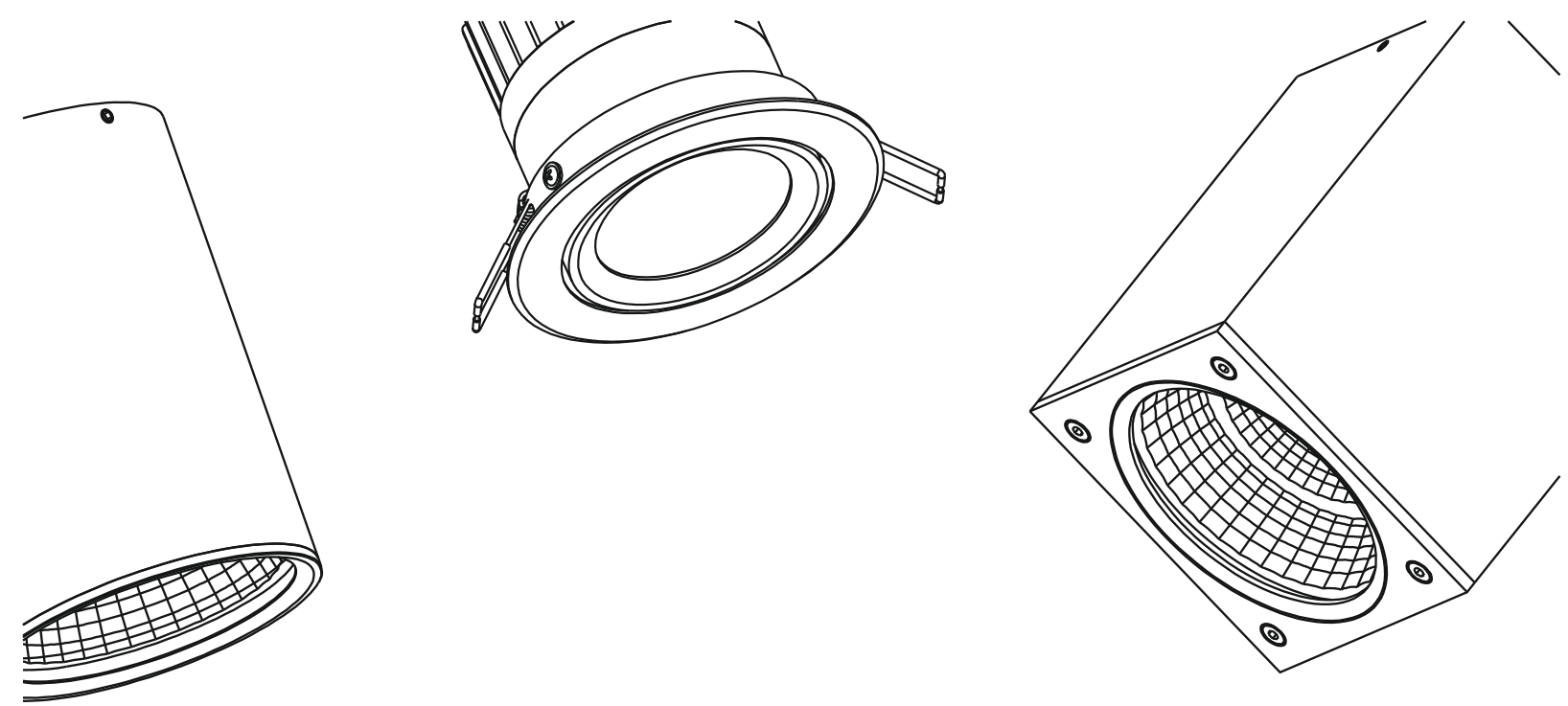

LED OUTDOOR CEILING LIGHTS





EXTERIOR
RECESSED MOUNTED
CEILING SPOTLIGHT

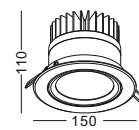

code **GD-LDC337**
casing aluminum / black painting
lamping COB 12W / Ra>90 /900LM
Beam 15/24/38/60 degree
2700K/3000K/4000K/6000K
installation     IP65

 cut-out dia125mm





surface
customizable
 white paint
similar to RAL9003
 concrete grey paint
similar to RAL7037

code **GD-LDC336**
casing aluminum / black painting
lamping COB 9W / Ra>90 /800LM
Beam 15/24/38/60 degree
2700K/3000K/4000K/6000K
installation     IP65

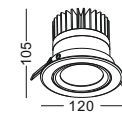
 cut-out dia100mm





surface
customizable
 white paint
similar to RAL9003
 concrete grey paint
similar to RAL7037

code **GD-LDC335**
casing aluminum / black painting
lamping COB 6W / Ra>90 /500LM
Beam 15/24/38/60 degree
2700K/3000K/4000K/6000K
installation     IP65

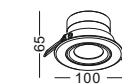
 cut-out dia 80mm



surface
customizable
 white paint
similar to RAL9003
 concrete grey paint
similar to RAL7037



OUTDOOR IP65 LED RECESSED DOWNLIGHT

surface
customizable

■ concrete grey paint
similar to RAL7037

■ white paint
similar to RAL9003

code **GD-LDC411**

casing aluminum / black painting

lampping COB 6W / Ra>90 / 500LM

Beam 15 / 24 / 38 / 60 degree

2700K/3000K/4000K/6000K

installation     IP65

 cut-off dia 70mm

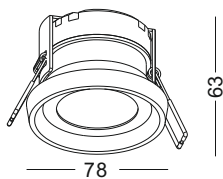

code **GD-LDC412**

casing aluminum / black painting

lampping COB 12W / Ra>90 / 900LM

Beam 15 / 24 / 38 / 60 degree

2700K/3000K/4000K/6000K

installation     IP65

 cut-off dia 115mm

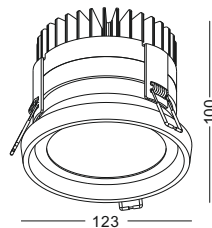

code **GD-LDC413**

casing aluminum / black painting

lampping COB 20W / Ra>90 / 1600LM

Beam 15 / 24 / 38 / 60 degree

2700K/3000K/4000K/6000K

installation     IP65

 cut-off dia 115mm

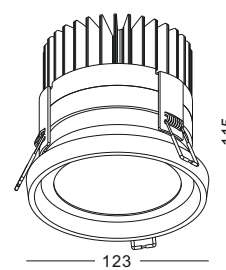

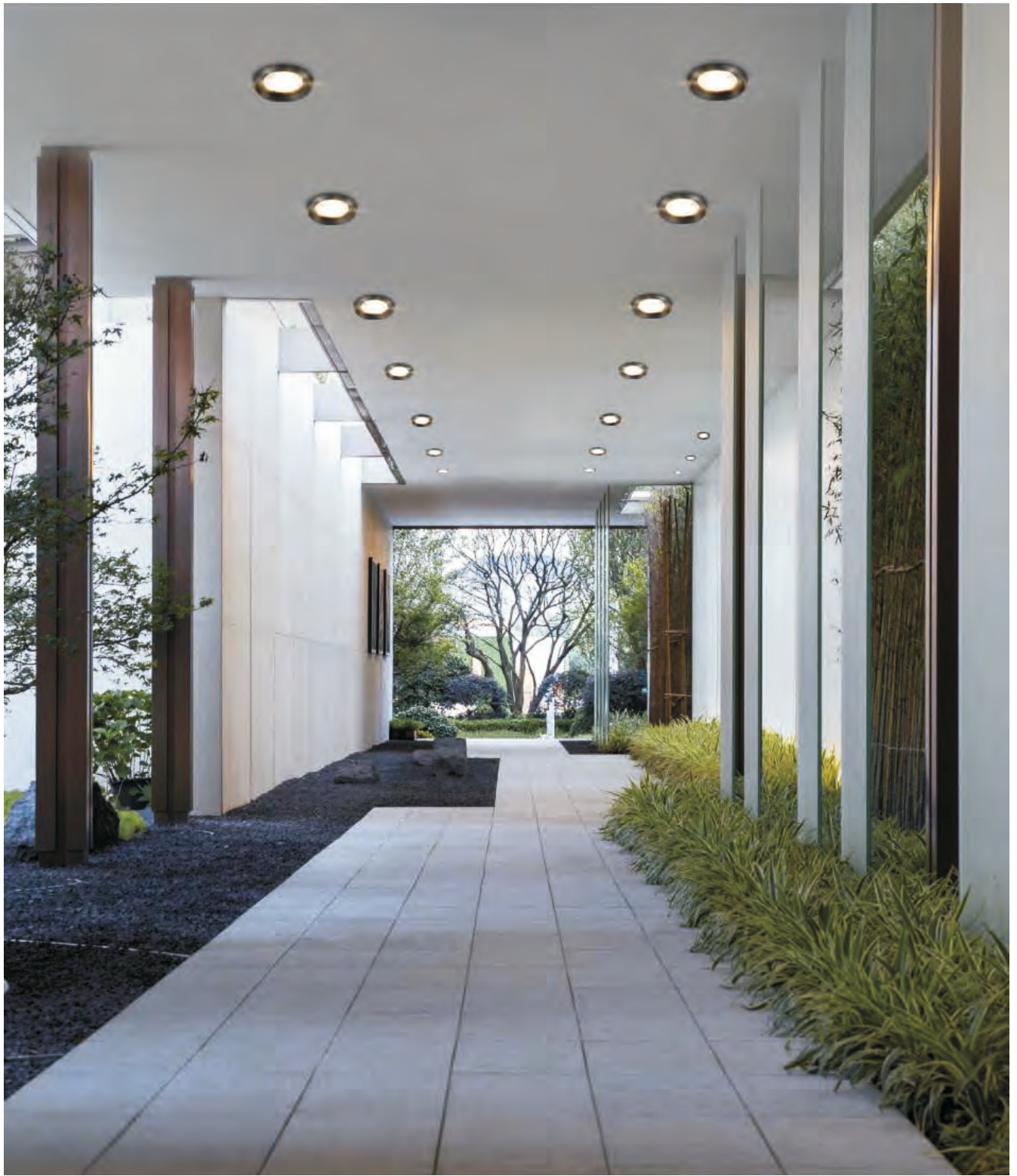



OUTDOOR IP65 LED RECESSED DOWNLIGHT ACRYLIC COVER

surface
customizable

- concrete grey paint
similar to RAL7037
- white paint
similar to RAL9003

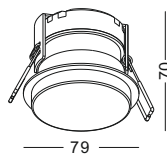

code **GD-LDC414**
casing aluminum / black painting
lamping LED 6W / Ra>80 / 600LM
Beam acrylic diffuser
2700K/3000K/4000K/6000K

installation     IP65

 cut-off dia 70mm

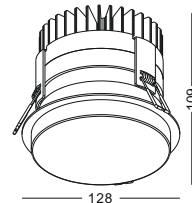

code **GD-LDC415**
casing aluminum / black painting
lamping LED 12W / Ra>80 / 1200LM
Beam acrylic diffuser
2700K/3000K/4000K/6000K

installation     IP65

 cut-off dia 115 mm



EXTERIOR
SURFACE MOUNTED
CEILING DOWNLIGHT

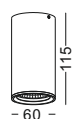

code **GD-LBL183**

surface customizable white paint similar to RAL9003 concrete grey paint similar to RAL7037

casing aluminum / black painting / lamping COB 5W / Ra>90 / 430LM / Beam 15/24/38/60 degree / 2700K/3000K/4000K/6000K

installation IP65

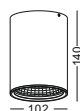

code **GD-LBL184**

surface customizable white paint similar to RAL9003 concrete grey paint similar to RAL7037

casing aluminum / black painting / lamping COB 12W / Ra>90 / 900LM / Beam 15/24/38/60 degree / 2700K/3000K/4000K/6000K

installation IP65



code **GD-LBL185**

surface customizable white paint similar to RAL9003 concrete grey paint similar to RAL7037

casing aluminum / black painting / lamping COB 20W / Ra>90 / 1700LM / Beam 15/24/38/60 degree / 2700K/3000K/4000K/6000K

installation IP65



EXTERIOR SURFACE MOUNTED CEILING DOWNLIGHT



code **GD-LBL186**

surface customizable  white paint similar to RAL9003  concrete grey paint similar to RAL7037

casing aluminum / black painting / lamping COB 5W / Ra>90 / 430LM / Beam 15/24/38/60 degree / 2700K/3000K/4000K/6000K

installation     IP65



code **GD-LBL187**



surface customizable  white paint similar to RAL9003  concrete grey paint similar to RAL7037

casing aluminum / black painting / lamping COB 12W / Ra>90 / 900LM / Beam 15/24/38/60 degree / 2700K/3000K/4000K/6000K

installation     IP65



code **GD-LBL188**

surface customizable  white paint similar to RAL9003  concrete grey paint similar to RAL7037

casing aluminum / black painting / lamping COB 20W / Ra>90 / 1700LM / Beam 15/24/38/60 degree / 2700K/3000K/4000K/6000K

installation     IP65



OUTDOOR IP65 LED SURFACE DOWNLIGHT ACRYLIC COVER

surface
customizable

- concrete grey paint
similar to RAL7037
- white paint
similar to RAL9003

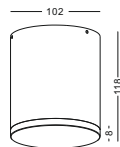

code **GD-LBL249**
casing aluminum / black painting
lamping LED 12W / Ra>80 / 1200LM
Beam acrylic diffuser
2700K/3000K/4000K/6000K
installation     IP65

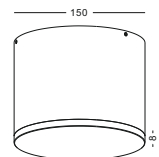

code **GD-LBL250**
casing aluminum / black painting
lamping LED 20W / Ra>80 / 2000LM
Beam acrylic diffuser
2700K/3000K/4000K/6000K
installation     IP65